

TYPE 22

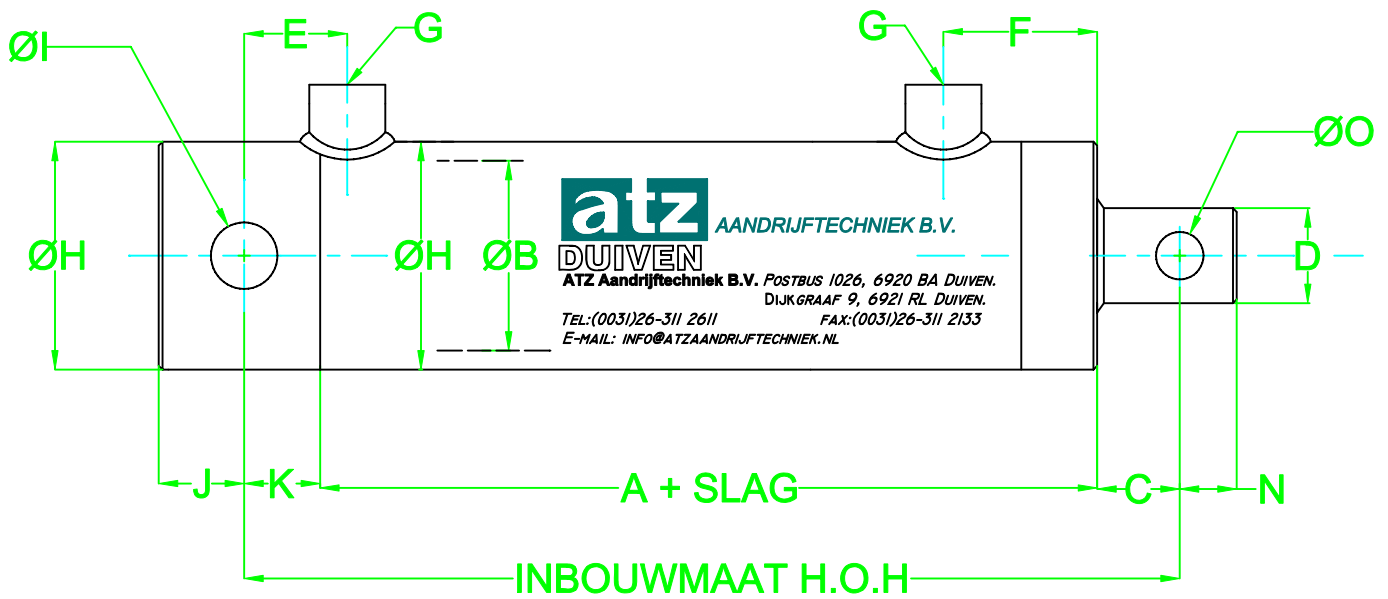

TYPE 22

BORING	STANG	A	B	C	D	E	F	G
25	15	85	25	20	15	29	48	1/4"
30	20	101	30	25	20	31	56	1/4"
40	25	108	40	30	25	41	56	1/4"
50	30	124	50	32	30	43	61	3/8"
60	35	130	60	34	35	44	65	3/8"
70	40	145	70	35	40	52	72	3/8"
80	45	160	80	37	45	51	83	1/2"
90	50	160	90	40	50	56	81	1/2"
100	50	160	100	40	50	56	81	1/2"
120	60	177	120	45	60	56	95	3/4"
120	70	177	120	45	70	-	95	3/4"
140	80	186	140	47	80	-	95	3/4"
160	90	198	160	50	90	-	100	3/4"
200	100	215	200	55	100	-	105	3/4"

H	I	J	K	N	O	P
35	10	17	23	10	8	1
40	12	20	25	15	10	1
50	15	25	30	20	12	1
60	16	28	32	20	15	1
70	20	30	35	22	16	2
80	25	32	38	25	20	2
95	30	35	40	27	25	2
110	30	40	40	30	25	2
120	35	45	40	30	25	2
140	40	50	40	35	30	3
140	-	-	-	37	30	3
160	-	-	-	40	35	3
180	-	-	-	45	40	3
220	-	-	-	50	50	3

TYPE 23

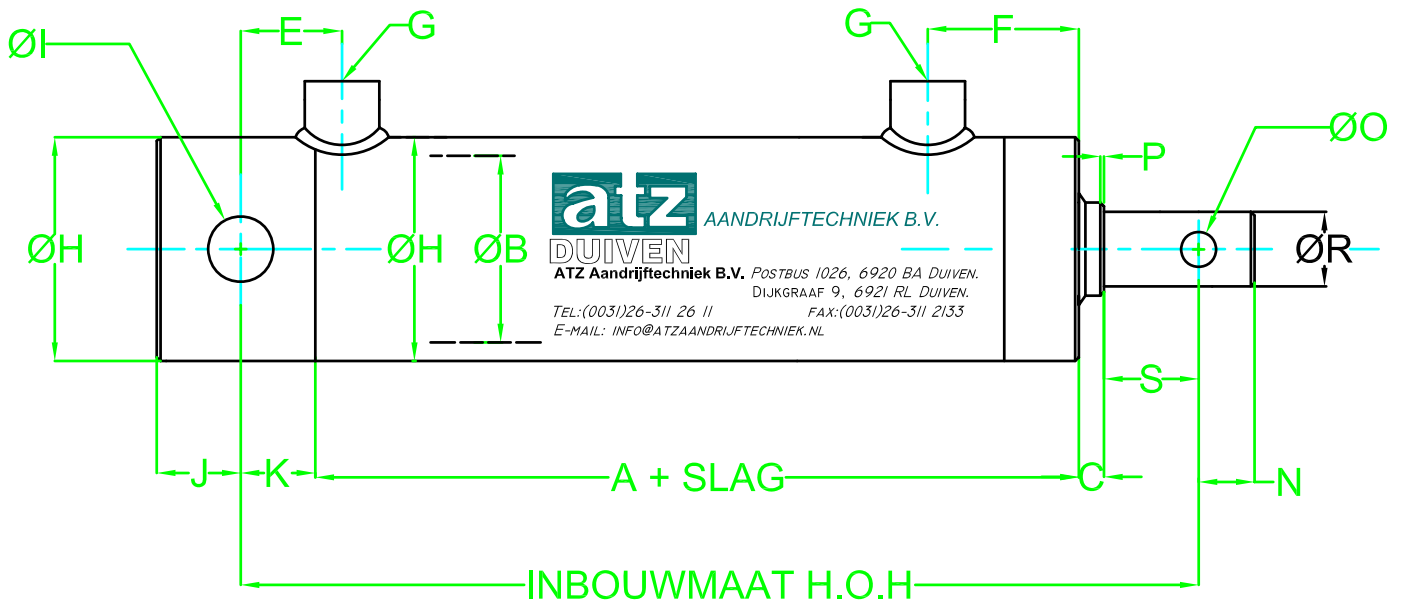

TYPE 23

BORING	STANG	A	B	C	D	E	F	G
25	15	85	25	6	15	29	48	1/4"
30	20	101	30	7	20	31	56	1/4"
40	25	108	40	8	25	41	56	1/4"
50	30	124	50	10	30	43	61	3/8"
60	35	130	60	10	35	44	65	3/8"
70	40	145	70	10	40	52	72	3/8"
80	45	160	80	12	45	51	83	1/2"
90	50	160	90	12	50	56	81	1/2"
100	50	160	100	12	50	56	81	1/2"
120	60	177	120	15	60	56	95	3/4"
120	70	177	120	15	70	-	95	3/4"
140	80	186	140	15	80	-	95	3/4"
160	90	198	160	15	90	-	100	3/4"
200	100	215	200	15	100	-	105	3/4"

H	I	J	K	N	O	P	R	S
35	10	17	23	10	7	1	12	14
40	12	20	25	12	9	1	15	18
50	15	25	30	15	12	1	20	22
60	16	28	32	15	15	2	25	22
70	20	30	35	18	16	2	30	24
80	25	32	38	20	20	2	35	25
95	30	35	40	25	20	2	40	25
110	30	40	40	25	25	3	45	28
120	35	45	40	25	25	3	45	28
140	40	50	40	30	30	4	50	30
140	-	-	-	30	30	4	60	30
160	-	-	-	35	30	4	70	35
180	-	-	-	40	35	4	80	40
220	-	-	-	45	40	4	90	45

TYPE 24

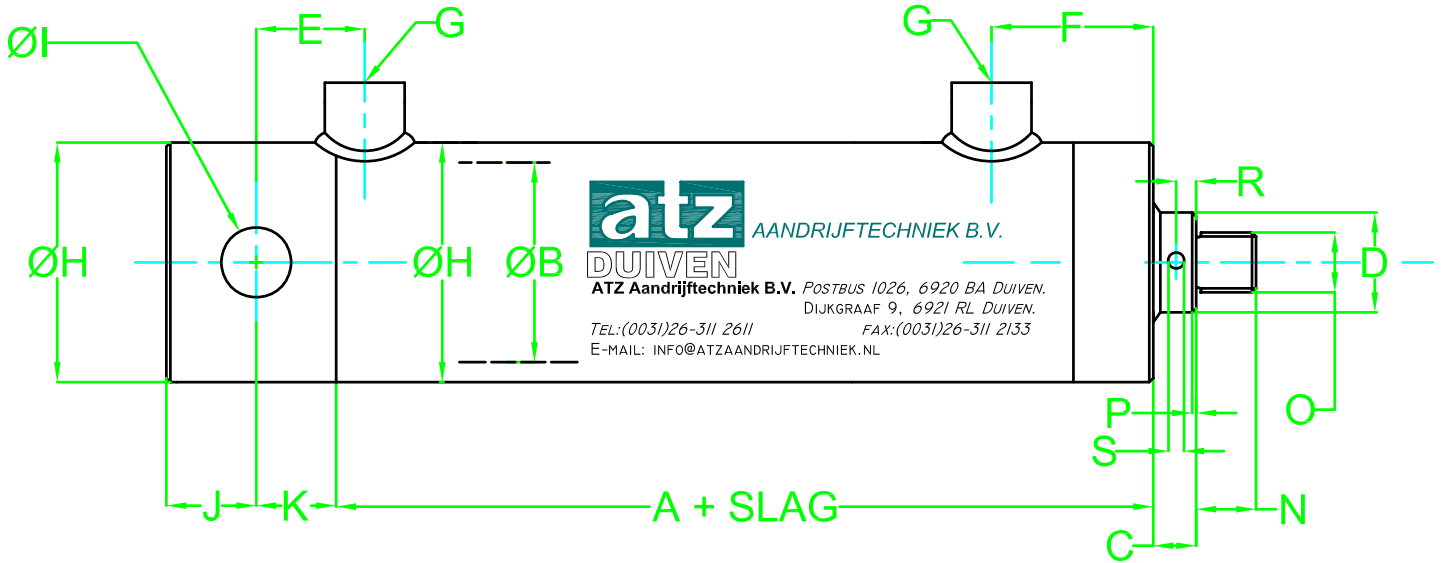

TYPE 24

BORING STANG	A	B	C	D	E	F	G
25	15	85	25	11	15	29	1/4"
30	20	101	30	12	20	31	1/4"
40	25	108	40	12	25	41	1/4"
50	30	124	50	14	30	43	3/8"
60	35	130	60	15	35	44	3/8"
70	40	145	70	15	40	52	3/8"
80	45	160	80	20	45	51	1/2"
90	50	160	90	20	50	56	1/2"
100	50	160	100	20	50	56	1/2"
120	60	177	120	20	60	56	3/4"
120	70	177	120	22	70	-	3/4"
140	80	186	140	22	80	-	3/4"
160	90	198	160	22	90	-	3/4"
200	100	215	200	24	100	-	3/4"

H	I	J	K	N	O	P	R	S
35	10	17	23	14	12X1,5	1	5	4
40	12	20	25	15	16X1,5	1	6	5
50	15	25	30	18	16X1,5	1	6	5
60	16	28	32	18	18X1,5	2	7	6
70	20	30	35	25	20X1,5	2	7	6
80	25	32	38	25	22X1,5	2	7	6
95	30	35	40	30	27X1,5	3	10	8
110	30	40	40	30	27X2	3	10	8
120	35	45	40	30	30X2	3	10	8
140	40	50	40	50	33X2	3	10	8
140	-	-	-	50	33X2	4	12	10
160	-	-	-	50	40X2	4	12	10
180	-	-	-	60	50X2	4	12	10
220	-	-	-	60	64X2	4	12	10

TYPE 25

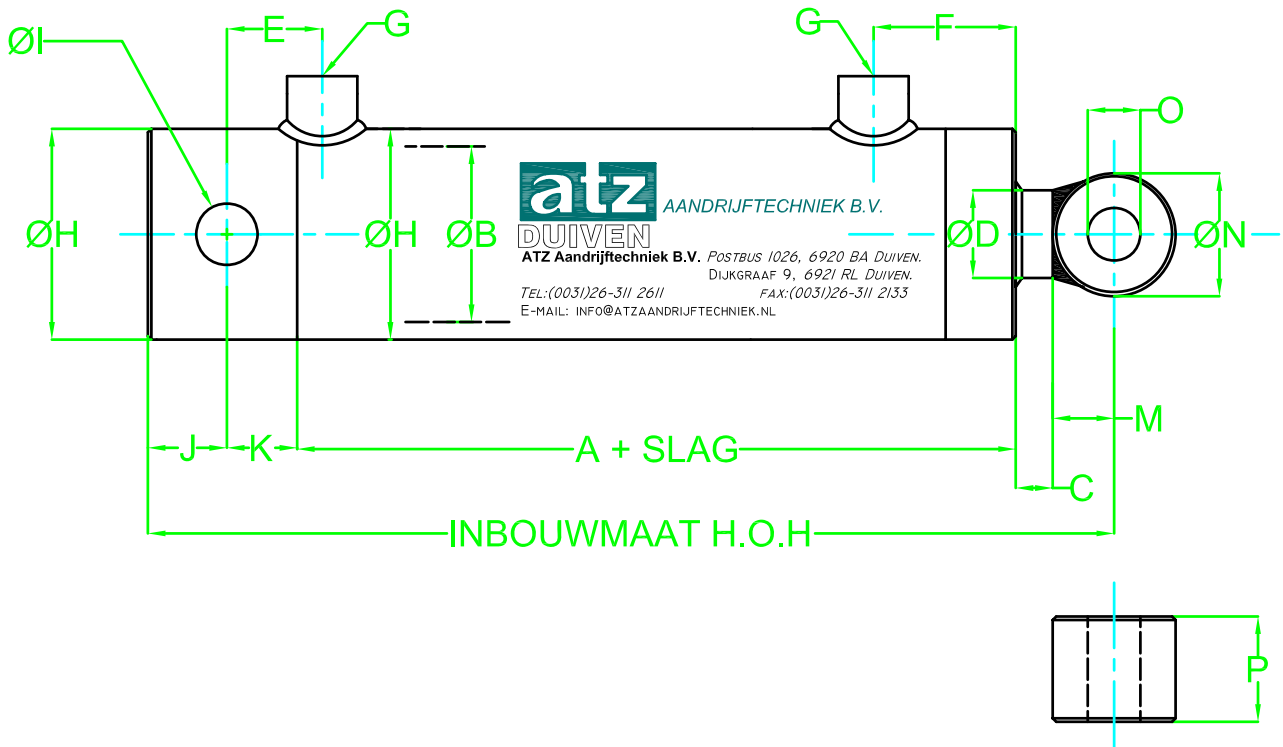

TYPE 25

BORING STANG	A	B	C	D	E	F	G	
25	15	85	25	16	15	29	48	1/4"
30	20	101	30	16	20	31	56	1/4"
40	25	108	40	16	25	41	56	1/4"
50	30	124	50	16	30	43	61	3/8"
60	35	130	60	16	35	44	65	3/8"
70	40	145	70	16	40	52	72	3/8"
80	45	160	80	21	45	51	83	1/2"
90	50	160	90	21	50	56	81	1/2"
100	50	160	100	21	50	56	81	1/2"
120	60	177	120	24	60	56	95	3/4"
120	70	177	120	24	70	-	95	3/4"
140	80	186	140	26	80	-	95	3/4"
160	90	198	160	33	90	-	100	3/4"
200	100	215	200	36	100	-	105	3/4"

H	I	J	K	M	N	O	P
35	10	17	23	15	30	10	25
40	12	20	25	20	40	12	30
50	15	25	30	20	40	16	35
60	16	28	32	25	50	20	40
70	20	30	35	30	60	20	45
80	25	32	38	30	60	25	50
95	30	35	40	30	60	25	55
110	30	40	40	35	70	30	60
120	35	45	40	35	70	30	60
140	40	50	40	40	80	35	70
140	-	-	-	40	80	35	80
160	-	-	-	45	90	40	90
180	-	-	-	50	100	45	100
220	-	-	-	60	120	50	110

TYPE 26

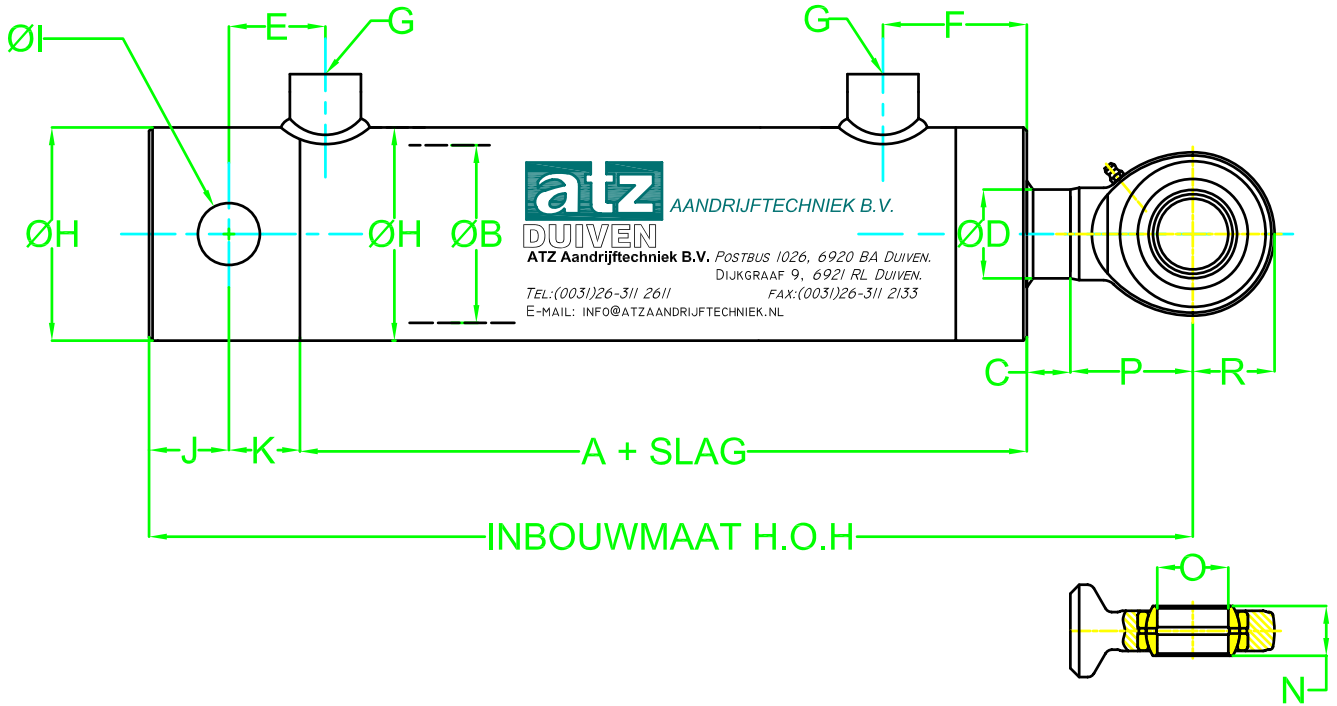

TYPE 26

BORING STANG	A	B	C	D	E	F	G	
25	15	85	25	16	15	29	48	1/4"
30	20	101	30	16	20	31	56	1/4"
40	25	108	40	16	25	41	56	1/4"
50	30	124	50	16	30	43	61	3/8"
60	35	130	60	16	35	44	65	3/8"
70	40	145	70	16	40	52	72	3/8"
80	45	160	80	21	45	51	83	1/2"
90	50	160	90	21	50	56	81	1/2"
100	50	160	100	21	50	56	81	1/2"
120	60	177	120	24	60	56	95	3/4"
120	70	177	120	24	70	-	95	3/4"
140	80	186	140	26	80	-	95	3/4"
160	90	198	160	33	90	-	100	3/4"
200	100	215	200	36	100	-	105	3/4"

H	I	J	K	N	O	P	R
35	10	17	23	9	10	24	15
40	12	20	25	10	12	27	17
50	15	25	30	12	15	31	20
60	16	28	32	14	16	35	23
70	20	30	35	16	20	38	27
80	25	32	38	20	25	45	32
95	30	35	40	22	30	51	37
110	30	40	40	25	35	61	41
120	35	45	40	28	40	69	46
140	40	50	40	32	45	77	51
140	-	-	-	35	50	88	56
160	-	-	-	44	60	100	68
180	-	-	-	49	70	115	80
220	-	-	-	55	80	141	90

TYPE 27

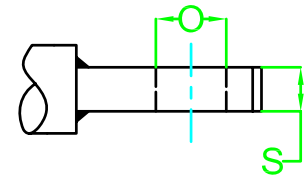
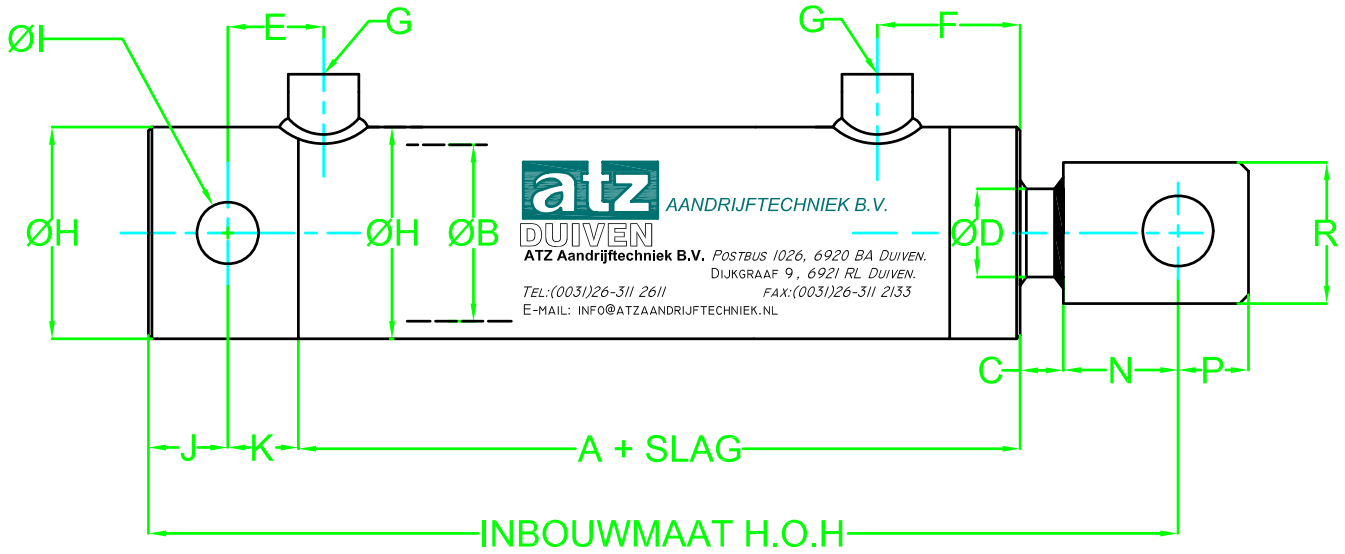

TYPE 27

BORING STANG		A	B	C	D	E	F	G
25	15	85	25	16	15	29	48	1/4"
30	20	101	30	16	20	31	56	1/4"
40	25	108	40	16	25	41	56	1/4"
50	30	124	50	16	30	43	61	3/8"
60	35	130	60	16	35	44	65	3/8"
70	40	145	70	16	40	52	72	3/8"
80	45	160	80	21	45	51	83	1/2"
90	50	160	90	21	50	56	81	1/2"
100	50	160	100	21	50	56	81	1/2"
120	60	177	120	24	60	56	95	3/4"
120	70	177	120	24	70	-	95	3/4"
140	80	186	140	26	80	-	95	3/4"
160	90	198	160	33	90	-	100	3/4"
200	100	215	200	36	100	-	105	3/4"

H	I	J	K	N	O	P	R	S
35	10	17	23	25	10	15	30	10
40	12	20	25	30	12	20	40	12
50	15	25	30	35	15	20	40	15
60	16	28	32	40	16	20	40	20
70	20	30	35	45	20	25	50	25
80	25	32	38	50	25	30	60	25
95	30	35	40	55	30	30	60	30
110	30	40	40	60	35	40	75	25
120	35	45	40	65	40	40	80	25
140	40	50	40	65	40	40	80	30
140	-	-	-	70	50	50	100	30
160	-	-	-	75	50	50	100	40
180	-	-	-	75	50	50	100	50
220	-	-	-	75	50	50	100	50

TYPE 28

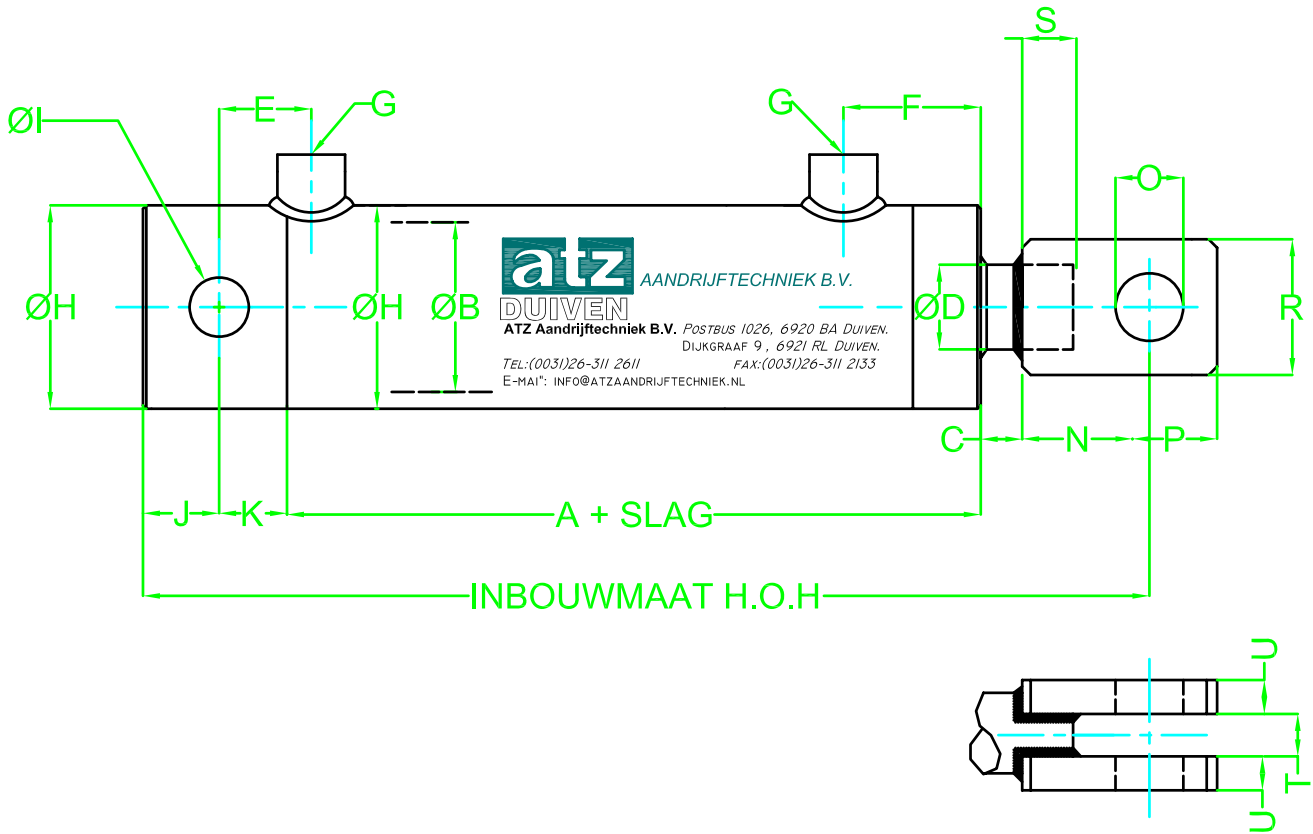

TYPE 28

BORING STANG	A	B	C	D	E	F	G	H	
25	15	85	25	10	15	29	48	1/4"	35
30	20	101	30	10	20	31	56	1/4"	40
40	25	108	40	10	25	41	56	1/4"	50
50	30	124	50	10	30	43	61	3/8"	60
60	35	130	60	13	35	44	65	3/8"	70
70	40	145	70	13	40	52	72	3/8"	80
80	45	160	80	13	45	54	83	1/2"	95
90	50	160	90	15	50	56	81	1/2"	110
100	50	160	100	15	50	56	81	1/2"	120
120	60	177	120	15	60	56	95	3/4"	140
120	70	177	120	18	70	-	95	3/4"	140
140	80	186	140	18	80	-	95	3/4"	160
160	90	198	160	20	90	-	100	3/4"	180
200	100	215	200	20	100	-	105	3/4"	220

I	J	K	N	O	P	R	S	T	U
10	17	23	40	10	15	30	15	10	8
12	20	25	45	12	20	40	15	12	8
15	25	30	50	16	20	40	20	15	10
16	28	32	55	20	20	40	20	20	12
20	30	35	60	20	25	50	25	20	12
25	32	38	65	25	30	60	25	20	15
30	35	40	70	30	30	60	25	25	15
30	40	40	75	35	40	75	25	25	15
35	45	40	85	40	40	80	30	25	20
40	50	40	95	40	40	80	35	30	20
-	-	-	100	50	50	100	35	30	20
-	-	-	110	50	50	100	40	40	25
-	-	-	125	50	50	100	50	50	30
-	-	-	125	50	50	100	50	50	30

TYPE 29

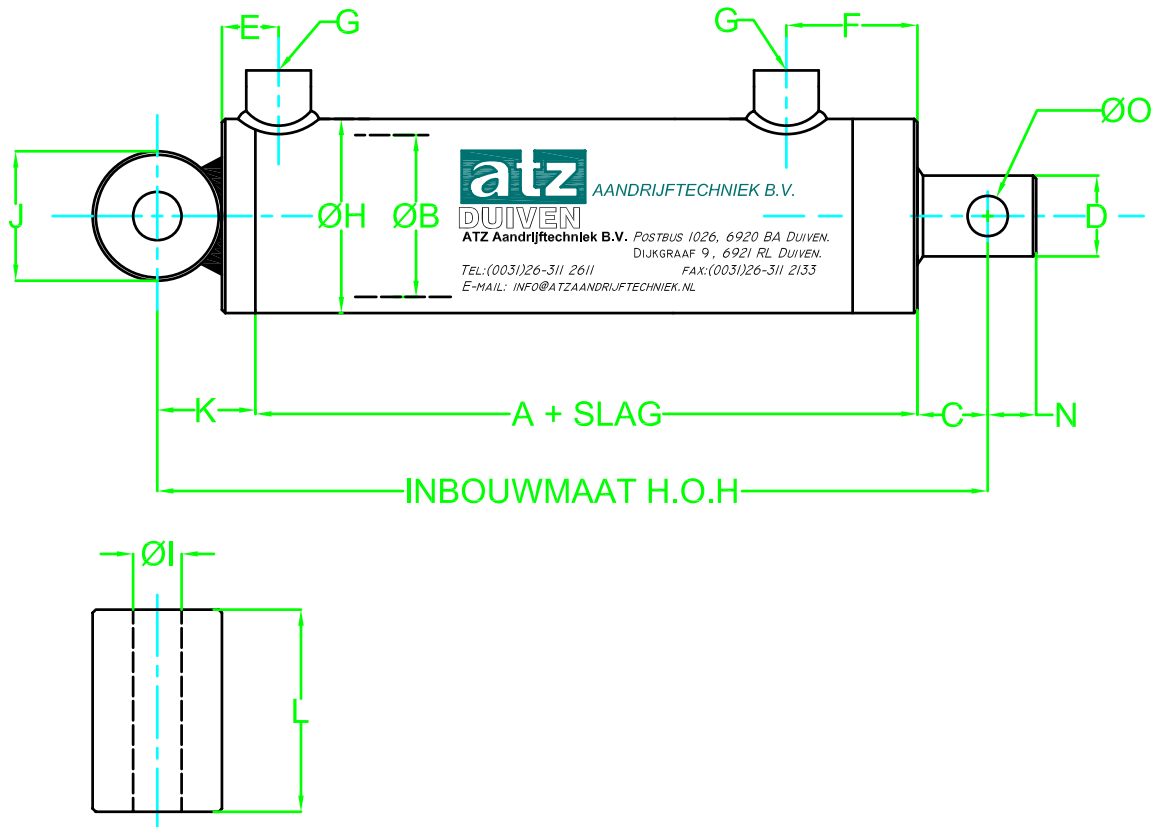

TYPE 29

BORING STANG	A	B	C	D	E	F	G	
25	15	94	25	20	15	15	48	1/4"
30	20	110	30	25	20	15	56	1/4"
40	25	117	40	30	25	20	56	1/4"
50	30	133	50	32	30	20	61	3/8"
60	35	141	60	34	35	20	65	3/8"
70	40	156	70	35	40	25	72	3/8"
80	45	174	80	37	45	25	83	1/2"
90	50	179	90	40	50	35	81	1/2"
100	50	179	100	40	50	35	81	1/2"
120	60	196	120	45	60	35	95	3/4"
120	70	196	120	45	70	35	95	3/4"
140	80	210	140	47	80	40	95	3/4"
160	90	232	160	50	90	50	100	3/4"
200	100	254	200	55	100	55	105	3/4"

H	I	J	K	L	N	O	P
35	10	30	15	40	10	8	1
40	12	40	20	45	15	10	1
50	16	40	20	55	20	12	1
60	20	50	25	65	20	15	1
70	20	60	30	75	22	16	2
80	25	70	35	85	25	20	2
95	25	70	35	100	27	25	2
110	30	80	40	115	30	25	2
120	30	80	40	125	30	25	2
140	35	90	45	145	35	30	3
140	35	90	45	145	37	30	3
160	40	100	50	165	40	35	3
180	45	120	60	185	45	40	3
220	50	120	60	225	50	50	3

TYPE 30

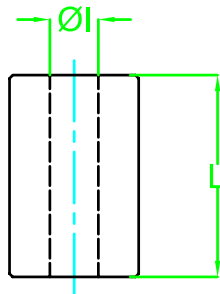
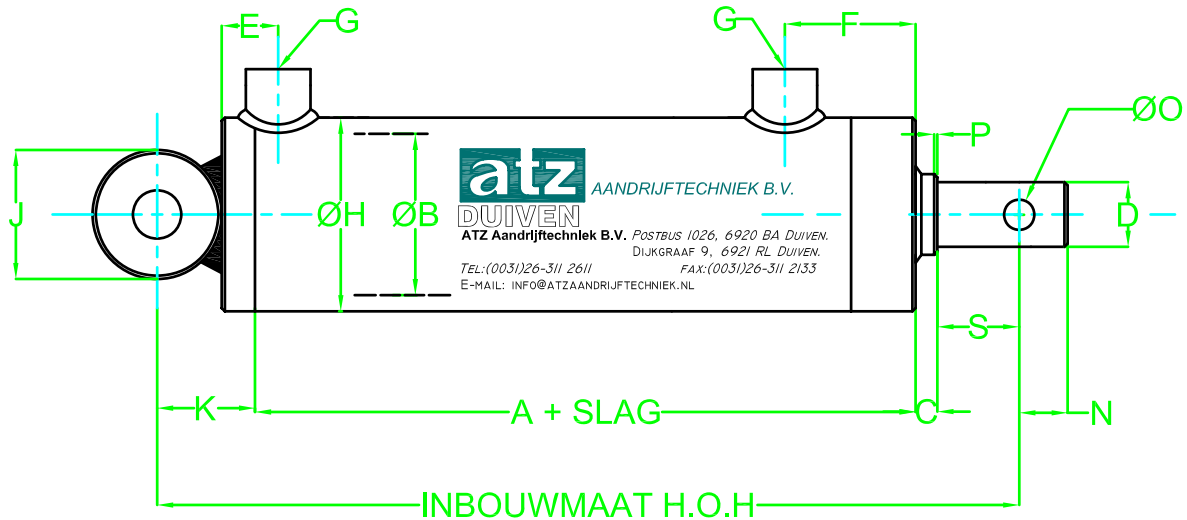

TYPE 30

BORING STANG	A	B	C	D	E	F	G	H	
25	15	94	25	6	15	15	48	1/4"	35
30	20	110	30	7	20	15	56	1/4"	40
40	25	117	40	8	25	20	56	1/4"	50
50	30	133	50	10	30	20	61	3/8"	60
60	35	141	60	10	35	20	65	3/8"	70
70	40	156	70	10	40	25	72	3/8"	80
80	45	174	80	12	45	25	83	1/2"	95
90	50	179	90	12	50	35	81	1/2"	110
100	50	179	100	12	50	35	81	1/2"	120
120	60	196	120	15	60	35	95	3/4"	140
120	70	196	120	15	70	35	95	3/4"	140
140	80	210	140	15	80	40	95	3/4"	160
160	90	232	160	15	90	50	100	3/4"	180
200	100	254	200	15	100	55	105	3/4"	220

I	J	K	L	N	O	P	R	S
10	30	15	40	10	7	1	12	14
12	40	20	45	12	9	1	15	18
16	40	20	55	15	12	1	20	22
20	50	25	65	15	15	2	25	22
20	60	30	75	18	16	2	30	24
25	70	35	85	20	20	2	35	25
25	70	35	100	25	20	2	40	25
30	80	40	115	25	25	3	45	28
30	80	40	125	25	25	3	45	28
35	90	45	145	30	30	4	50	30
35	90	45	145	30	30	4	60	30
40	100	50	165	35	30	4	70	35
45	120	60	185	40	35	4	80	40
50	120	60	225	45	40	4	90	45

TYPE 31

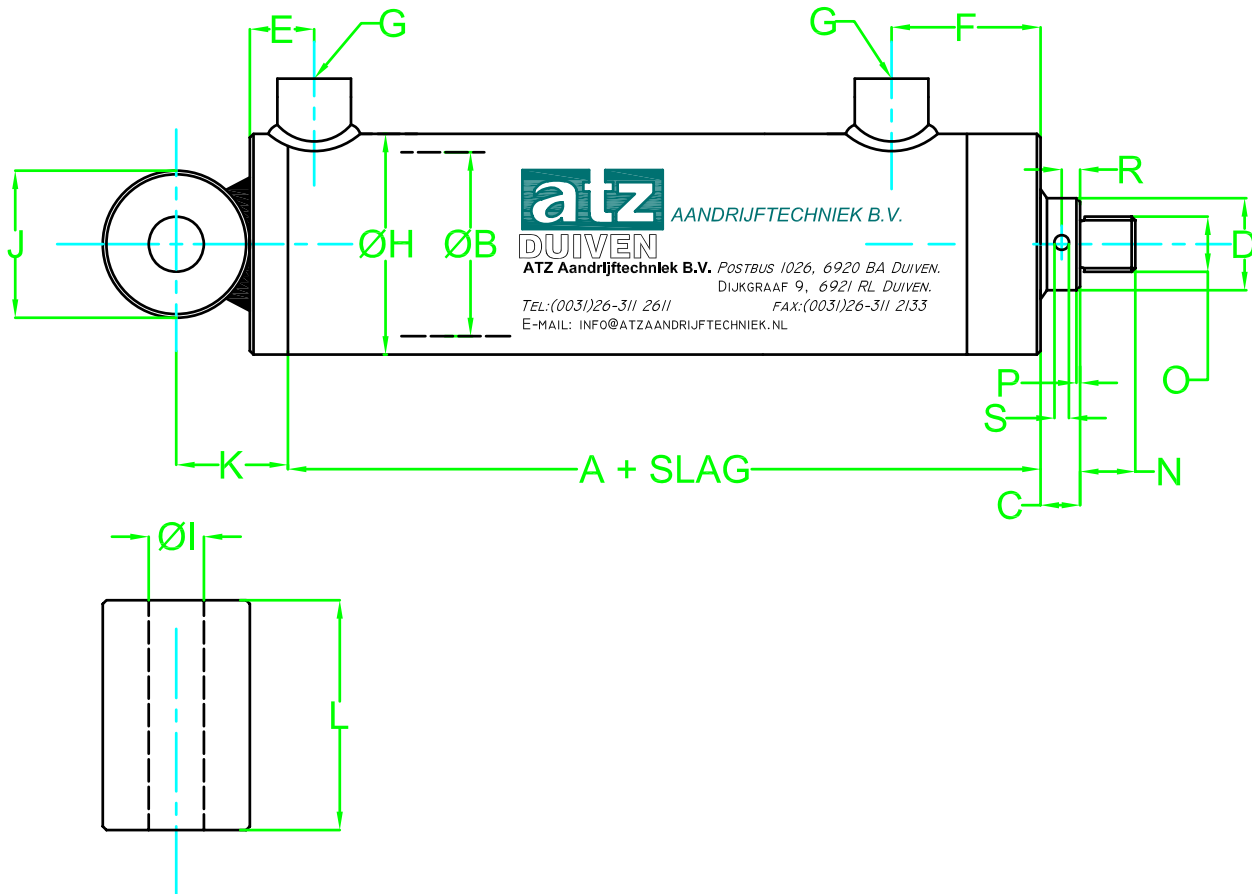

TYPE 31

BORING STANG	A	B	C	D	E	F	G	
25	15	94	25	11	15	15	48	1/4"
30	20	110	30	12	20	15	56	1/4"
40	25	117	40	12	25	20	56	1/4"
50	30	133	50	14	30	20	61	3/8"
60	35	141	60	15	35	20	65	3/8"
70	40	156	70	15	40	25	72	3/8"
80	45	174	80	20	45	25	83	1/2"
90	50	179	90	20	50	35	81	1/2"
100	50	179	100	20	50	35	81	1/2"
120	60	196	120	20	60	35	95	3/4"
120	70	196	120	22	70	35	95	3/4"
140	80	210	140	22	80	40	95	3/4"
160	90	232	160	22	90	50	100	3/4"
200	100	254	200	24	100	55	105	3/4"

H	I	J	K	L	N	O	P	R	S
35	10	30	15	40	14	14X1,5	1	5	4
40	12	40	20	45	15	16X1,5	1	6	5
50	16	40	20	55	18	16X1,5	1	6	5
60	20	50	25	65	18	18X1,5	2	7	6
70	20	60	30	75	25	20X1,5	2	7	6
80	25	70	35	85	25	22X1,5	2	7	6
95	25	70	35	100	30	27X2	3	10	8
110	30	80	40	115	30	27X2	3	10	8
120	30	80	40	125	30	30X2	3	10	8
140	35	90	45	145	50	33X2	3	10	8
140	35	90	45	145	50	33X2	4	12	10
160	40	100	50	165	50	40X2	4	12	10
180	45	120	60	185	60	50X2	4	12	10
220	50	120	60	225	60	64X3	4	12	10

TYPE 32

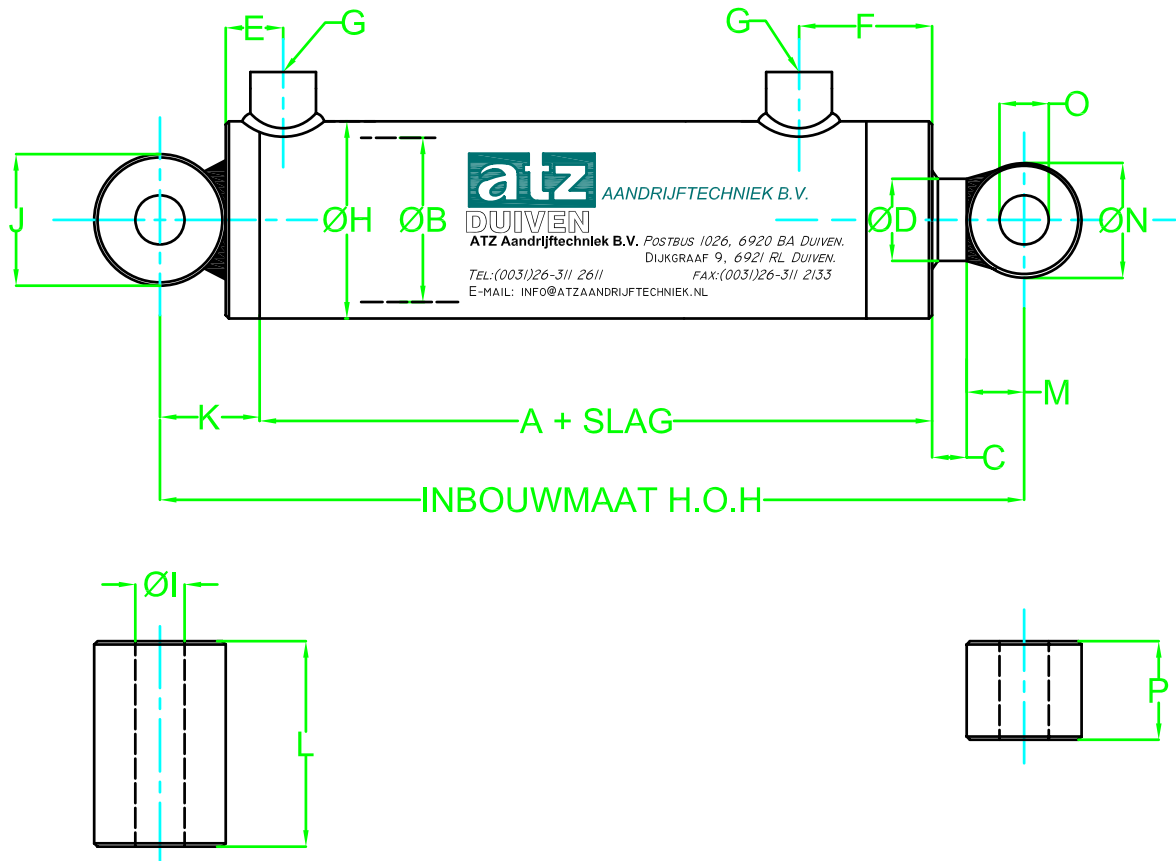

TYPE 32

BORING	STANG	A	B	C	D	E	F	G
25	15	94	25	16	15	15	48	1/4"
30	20	110	30	16	20	15	56	1/4"
40	25	117	40	16	25	20	56	1/4"
50	30	133	50	16	30	20	61	3/8"
60	35	141	60	16	35	20	65	3/8"
70	40	156	70	16	40	25	72	3/8"
80	45	174	80	21	45	25	83	1/2"
90	50	179	90	21	50	35	81	1/2"
100	50	179	100	21	50	35	81	1/2"
120	60	196	120	24	60	35	95	3/4"
120	70	196	120	24	70	35	95	3/4"
140	80	210	140	26	80	40	95	3/4"
160	90	232	160	33	90	50	100	3/4"
200	100	254	200	36	100	55	105	3/4"

H	I	J	K	L	M	N	O	P
35	10	30	15	40	15	30	10	25
40	12	40	20	45	20	40	12	30
50	16	40	20	55	20	40	16	35
60	20	50	25	65	25	50	20	40
70	20	60	30	75	30	60	20	45
80	25	70	35	85	30	60	25	50
95	25	70	35	100	30	60	25	55
110	30	80	40	115	35	70	30	60
120	30	80	40	125	35	70	30	60
140	35	90	45	145	40	80	35	70
140	35	90	45	145	40	80	35	80
160	40	100	50	165	45	90	40	90
180	45	120	60	185	50	100	45	100
220	50	120	60	225	60	120	50	110

TYPE 33

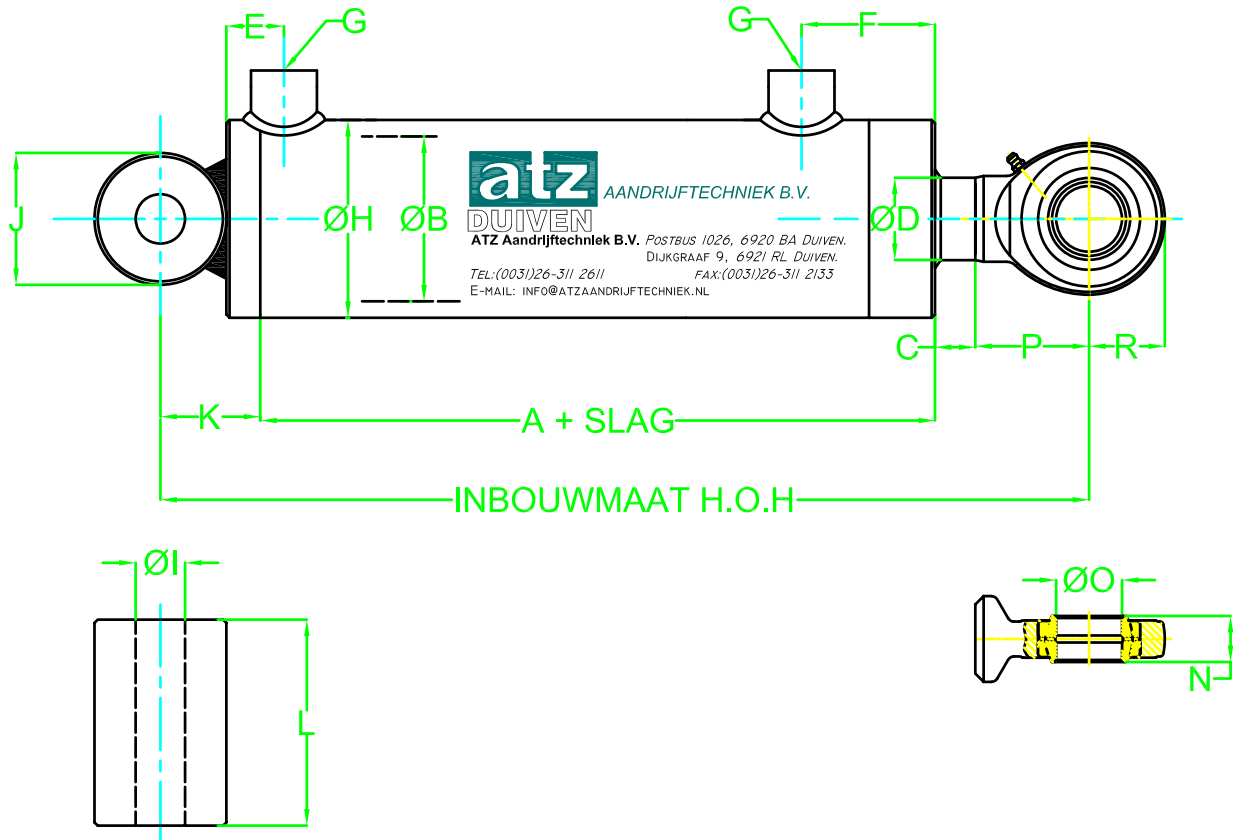

TYPE 33

BORING	STANG	A	B	C	D	E	F	G
25	15	94	25	16	15	15	48	1/4"
30	20	110	30	16	20	15	56	1/4"
40	25	117	40	16	25	20	56	1/4"
50	30	133	50	16	30	20	61	3/8"
60	35	141	60	16	35	20	65	3/8"
70	40	156	70	16	40	25	72	3/8"
80	45	174	80	21	45	25	83	1/2"
90	50	179	90	21	50	35	81	1/2"
100	50	179	100	21	50	35	81	1/2"
120	60	196	120	24	60	35	95	3/4"
120	70	196	120	24	70	35	95	3/4"
140	80	210	140	26	80	40	95	3/4"
160	90	232	160	33	90	50	100	3/4"
200	100	254	200	36	100	55	105	3/4"

H	I	J	K	L	N	O	P	R
35	10	30	15	40	9	10	24	15
40	12	40	20	45	10	12	27	17
50	16	40	20	55	12	15	31	20
60	20	50	25	65	14	17	35	23
70	20	60	30	75	16	20	38	27
80	25	70	35	85	20	25	45	32
95	25	70	35	100	22	30	51	37
110	30	80	40	115	25	35	61	41
120	30	80	40	125	28	40	69	46
140	35	90	45	145	32	45	77	51
140	35	90	45	145	35	50	88	56
160	40	100	50	165	44	60	100	68
180	45	120	60	185	49	70	115	80
220	50	120	60	225	55	80	141	90

TYPE 34

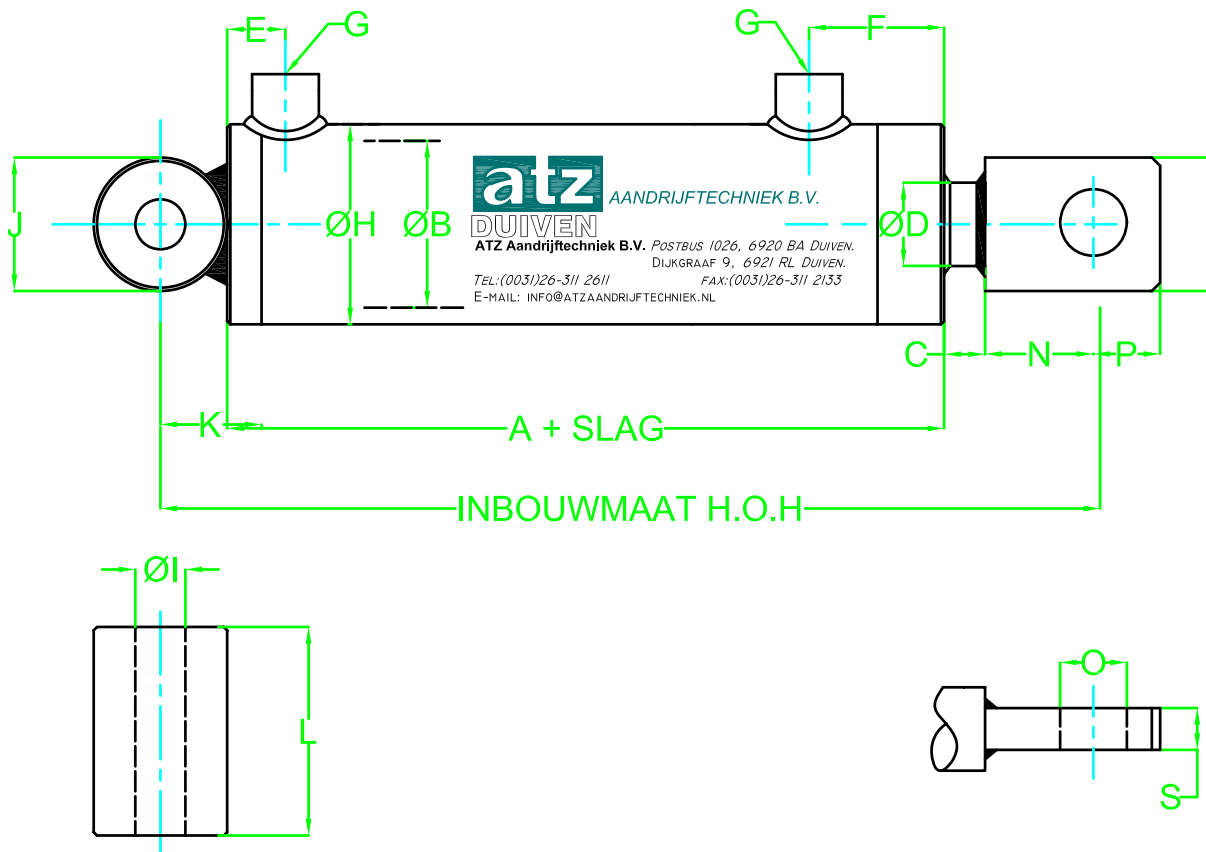

TYPE 34

BORINGSTANG	A	B	C	D	E	F	G	H	
25	15	94	25	16	15	15	48	1/4"	35
30	20	110	30	16	20	15	56	1/4"	40
40	25	117	40	16	25	20	56	1/4"	50
50	30	133	50	16	30	20	61	3/8"	60
60	35	141	60	16	35	20	65	3/8"	70
70	40	156	70	16	40	25	72	3/8"	80
80	45	174	80	21	45	25	83	1/2"	95
90	50	179	90	21	50	35	81	1/2"	110
100	50	179	100	21	50	35	81	1/2"	120
120	60	196	120	24	60	35	95	3/4"	140
120	70	196	120	24	70	35	95	3/4"	140
140	80	210	140	26	80	40	95	3/4"	160
160	90	232	160	33	90	50	100	3/4"	180
200	100	254	200	36	100	55	105	3/4"	220

I	J	K	L	N	O	P	R	S
10	30	15	40	25	10	15	30	10
12	40	20	45	30	12	20	40	12
16	40	20	55	35	16	20	40	15
20	50	25	65	40	20	20	40	20
20	60	30	75	45	20	25	50	25
25	70	35	85	50	25	30	60	25
25	70	35	100	55	30	30	60	25
30	80	40	115	60	35	40	75	25
30	80	40	125	65	40	40	80	25
35	90	45	145	65	40	40	80	30
35	90	45	145	70	50	50	100	30
40	100	50	165	75	50	50	100	40
45	120	60	185	75	50	50	100	50
50	120	60	225	75	50	50	100	50

TYPE 35

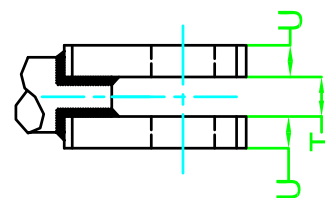
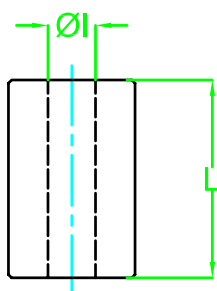
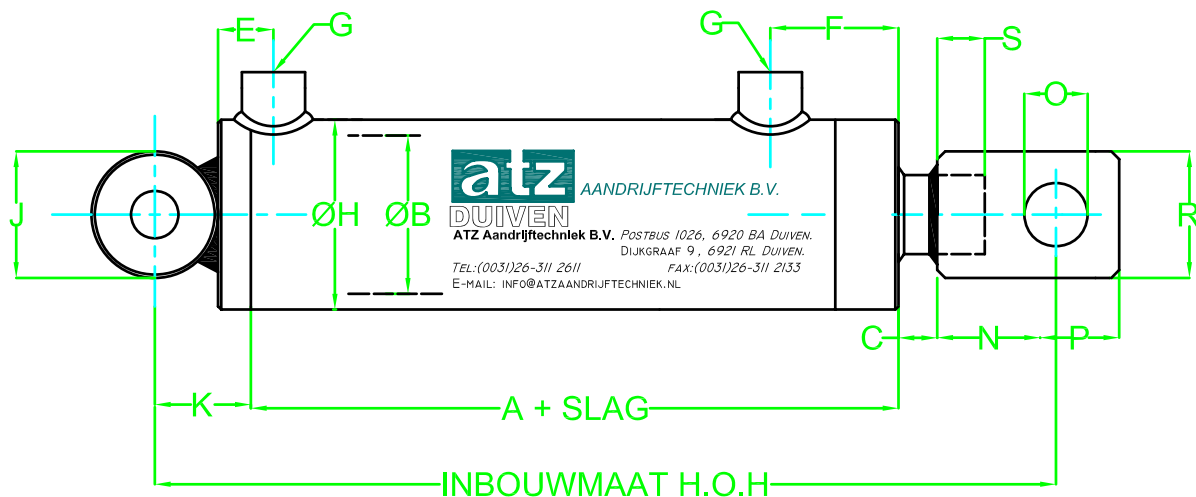

TYPE 35

BORINGSTANG	A	B	C	D	E	F	G	H	I
25	15	94	25	10	15	48	1/4"	35	10
30	20	110	30	10	20	56	1/4"	40	12
40	25	117	40	10	25	56	1/4"	50	16
50	30	133	50	10	30	61	3/8"	60	20
60	35	141	60	13	35	65	3/8"	70	20
70	40	156	70	13	40	72	3/8"	80	25
80	45	174	80	13	45	83	1/2"	95	25
90	50	179	90	15	50	81	1/2"	110	30
100	50	179	100	15	50	81	1/2"	120	30
120	60	196	120	15	60	95	3/4"	140	35
120	70	196	120	18	70	95	3/4"	140	35
140	80	210	140	18	80	95	3/4"	160	40
160	90	232	160	20	90	100	3/4"	180	45
200	100	254	200	20	100	105	3/4"	220	50

J	K	L	N	O	P	R	S	T	U
30	15	40	40	10	15	30	15	10	8
40	20	45	45	12	20	40	15	12	8
40	20	55	50	16	20	40	20	15	10
50	25	65	55	20	20	40	20	20	12
60	30	75	60	20	25	50	25	20	12
70	35	85	65	25	30	60	25	20	15
70	35	100	70	30	30	60	25	25	15
80	40	115	75	35	40	75	25	25	15
80	40	125	85	40	40	80	30	25	20
90	45	145	95	40	40	80	35	30	20
90	45	145	100	50	50	100	35	30	20
100	50	165	110	50	50	100	40	40	25
120	60	185	125	50	50	100	50	50	30
120	60	225	125	50	50	100	50	50	30

TYPE 36

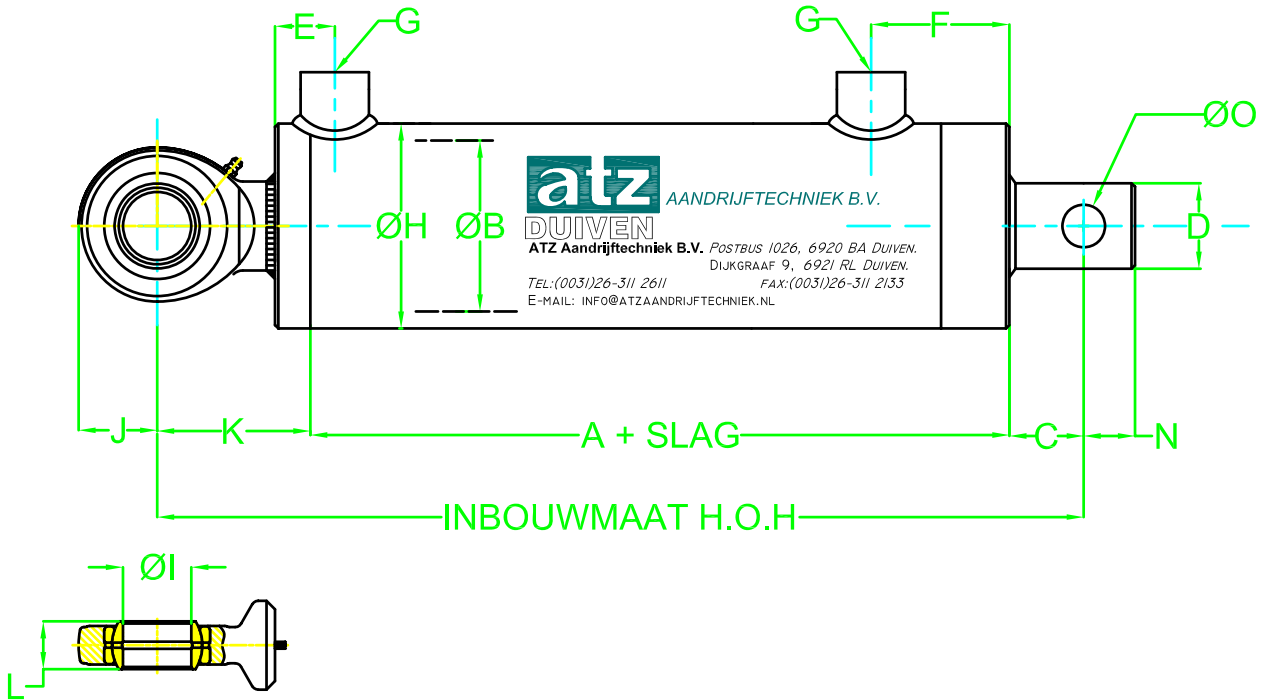

TYPE 36

BORING	STANG	A	B	C	D	E	F	G
25	15	94	25	20	15	15	48	1/4"
30	20	110	30	25	20	15	56	1/4"
40	25	117	40	30	25	20	56	1/4"
50	30	133	50	32	30	20	61	3/8"
60	35	141	60	34	35	20	65	3/8"
70	40	156	70	35	40	25	72	3/8"
80	45	174	80	37	45	25	83	1/2"
90	50	179	90	40	50	35	81	1/2"
100	50	179	100	40	50	35	81	1/2"
120	60	196	120	45	60	35	95	3/4"
120	70	196	120	45	70	35	95	3/4"
140	80	210	140	47	80	40	95	3/4"
160	90	232	160	50	90	50	100	3/4"
200	100	254	200	55	100	55	105	3/4"

H	I	J	K	L	N	O	P
35	10	15	24	9	10	8	1
40	12	17	27	10	15	10	1
50	15	20	31	12	20	12	1
60	17	23	35	14	20	15	1
70	20	27	38	16	22	16	2
80	25	32	45	20	25	20	2
95	30	37	51	22	27	25	2
110	35	41	61	25	30	25	2
120	40	46	69	28	30	25	2
140	45	51	77	32	35	30	3
140	50	56	88	35	37	30	3
160	60	68	100	44	40	35	3
180	70	80	115	49	45	40	3
220	80	90	141	55	50	50	3

TYPE 37

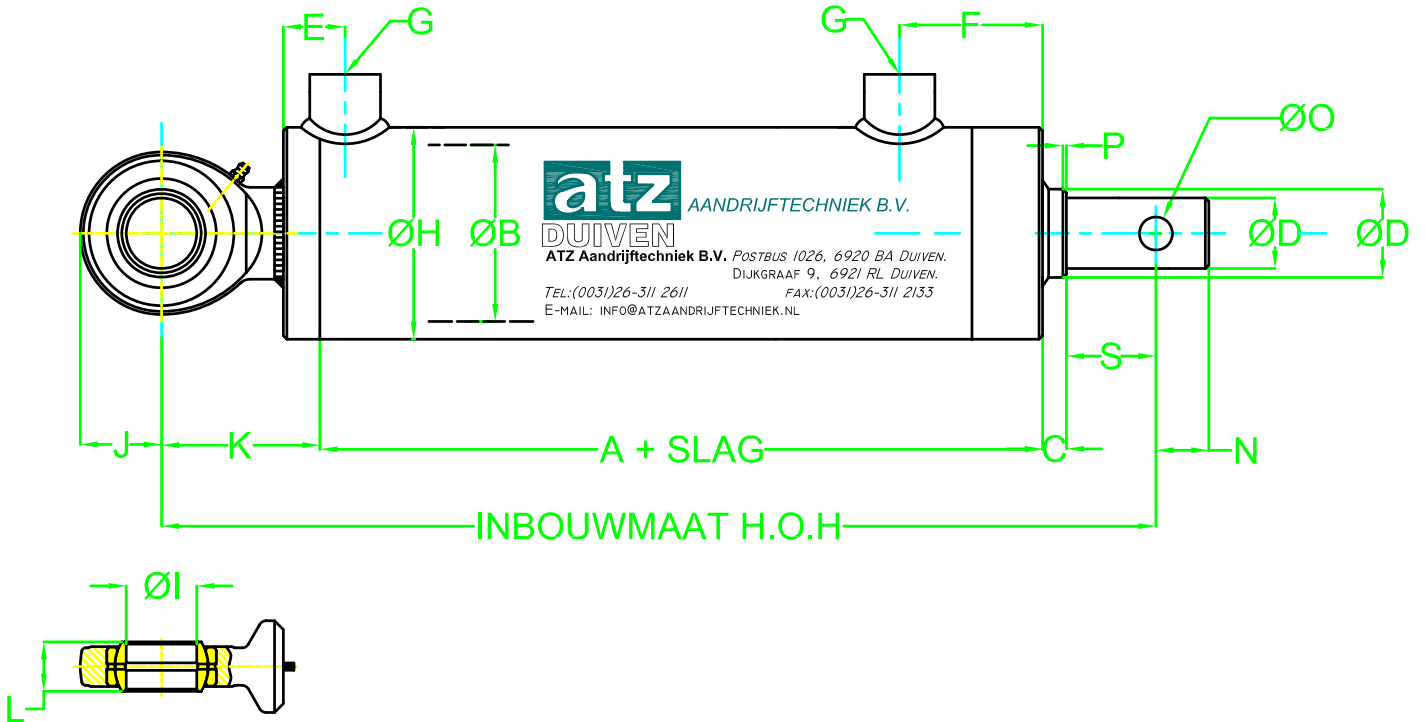

TYPE 37

BORING STANG	A	B	C	D	E	F	G	H	
25	15	94	25	6	15	15	48	1/4"	35
30	20	110	30	7	20	15	56	1/4"	40
40	25	117	40	8	25	20	56	1/4"	50
50	30	133	50	10	30	20	61	3/8"	60
60	35	141	60	10	35	20	65	3/8"	70
70	40	156	70	10	40	25	72	3/8"	80
80	45	174	80	12	45	25	83	1/2"	95
90	50	179	90	12	50	35	81	1/2"	110
100	50	179	100	12	50	35	81	1/2"	120
120	60	196	120	15	60	35	95	3/4"	140
120	70	196	120	15	70	35	95	3/4"	140
140	80	210	140	15	80	40	95	3/4"	160
160	90	232	160	15	90	50	100	3/4"	180
200	100	254	200	15	100	55	105	3/4"	220

I	J	K	L	N	O	P	R	S
10	15	24	9	10	7	1	12	14
12	17	27	10	12	9	1	15	18
15	20	31	12	15	12	1	20	22
17	23	35	14	15	15	2	25	22
20	27	38	16	18	16	2	30	24
25	32	45	20	20	20	2	35	25
30	37	51	22	25	20	2	40	25
35	41	61	25	25	25	3	45	28
40	46	69	28	25	25	3	45	28
45	51	77	32	30	30	4	50	30
50	56	88	35	30	30	4	60	30
60	68	100	44	35	30	4	70	35
70	80	115	49	40	35	4	80	40
80	90	141	55	45	40	4	90	45

TYPE 38

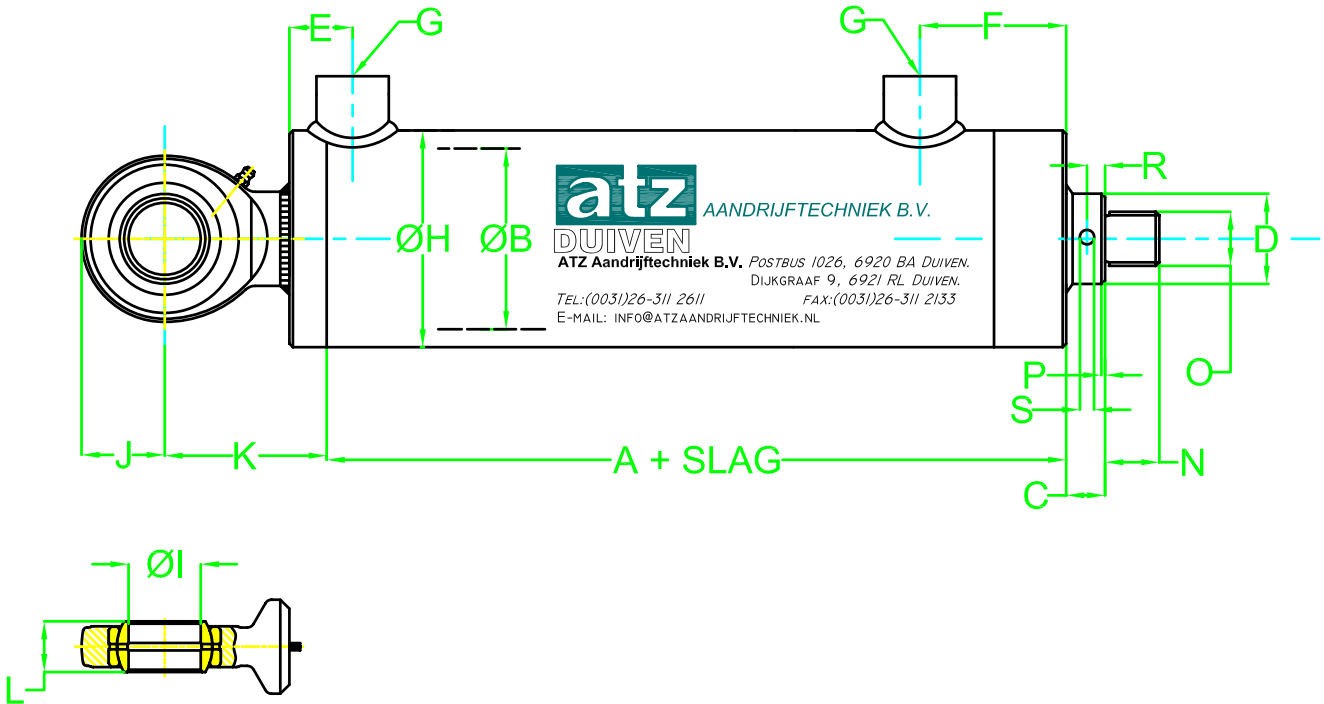

TYPE 38

BORING STANG	A	B	C	D	E	F	G	H	
25	15	94	25	11	15	15	48	1/4"	35
30	20	110	30	12	20	15	56	1/4"	40
40	25	117	40	12	25	20	56	1/4"	50
50	30	133	50	14	30	20	61	3/8"	60
60	35	141	60	15	35	20	65	3/8"	70
70	40	156	70	15	40	25	72	3/8"	80
80	45	174	80	20	45	25	83	1/2"	95
90	50	179	90	20	50	35	81	1/2"	110
100	50	179	100	20	50	35	81	1/2"	120
120	60	196	120	20	60	35	95	3/4"	140
120	70	196	120	22	70	35	95	3/4"	140
140	80	210	140	22	80	40	95	3/4"	160
160	90	232	160	22	90	50	100	3/4"	180
200	100	254	200	24	100	55	105	3/4"	220

I	J	K	L	N	O	P	R	S
10	15	24	9	14	14X1,5	1	5	4
12	17	27	10	15	16X1,5	1	6	5
15	20	31	12	18	16X1,5	1	6	5
17	23	35	14	18	20X1,5	2	7	6
20	27	38	16	25	20X1,5	2	7	6
25	32	45	20	25	22X1,5	2	7	6
30	37	51	22	30	27X2	3	10	8
35	41	61	25	30	27X2	3	10	8
40	46	69	28	30	30X2	3	10	8
45	51	77	32	50	33X2	3	10	8
50	56	88	35	50	33X2	4	12	10
60	68	100	44	50	40X2	4	12	10
70	80	115	49	60	50X2	4	12	10
80	90	141	55	60	64X2	4	12	10

TYPE 39

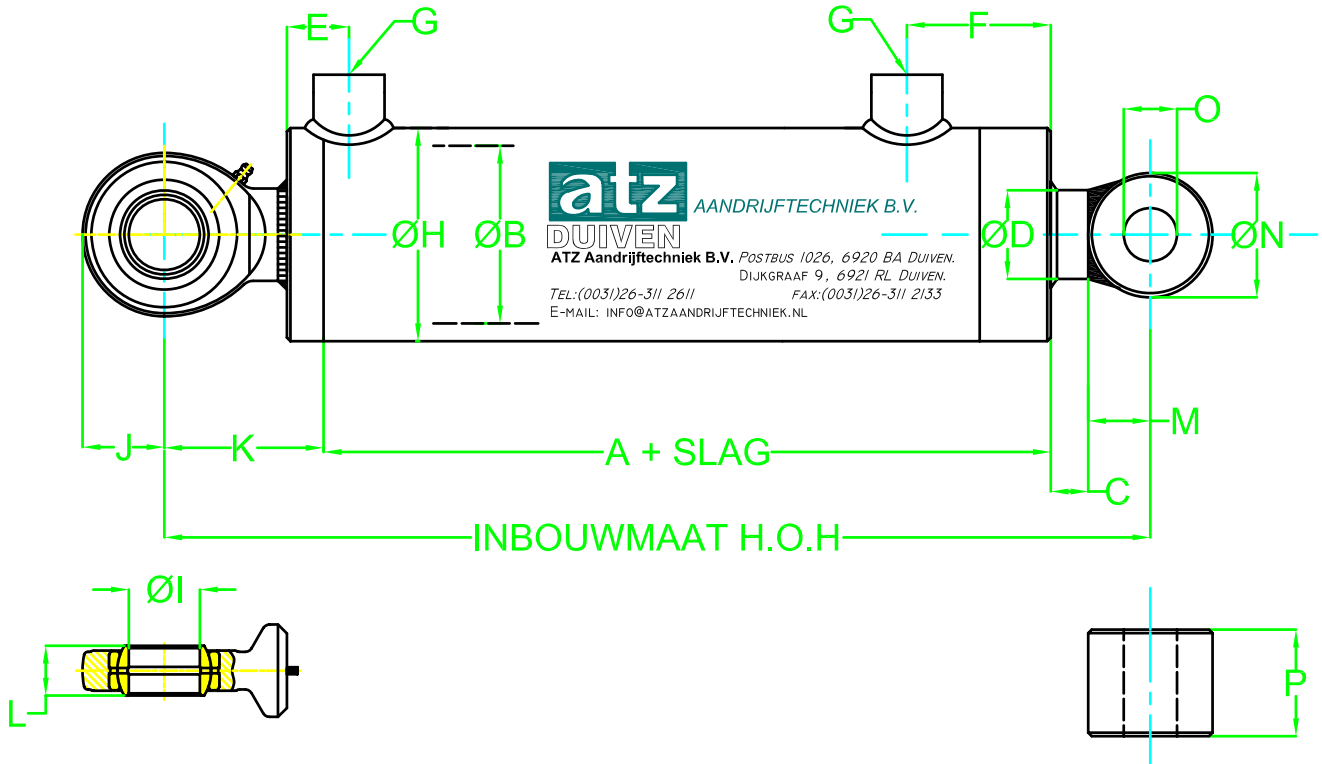

TYPE 39

BORING STANG	A	B	C	D	E	F	G	
25	15	94	25	16	15	15	48	1/4"
30	20	110	30	16	20	15	56	1/4"
40	25	117	40	16	25	20	56	1/4"
50	30	133	50	16	30	20	61	3/8"
60	35	141	60	16	35	20	65	3/8"
70	40	156	70	16	40	25	72	3/8"
80	45	174	80	21	45	25	83	1/2"
90	50	179	90	21	50	35	81	1/2"
100	50	179	100	21	50	35	81	1/2"
120	60	196	120	24	60	35	95	3/4"
120	70	196	120	24	70	35	95	3/4"
140	80	210	140	26	80	40	95	3/4"
160	90	232	160	33	90	50	100	3/4"
200	100	254	200	36	100	55	105	3/4"

H	I	J	K	L	M	N	O	P
35	10	15	24	9	15	30	10	25
40	12	17	27	10	20	40	12	30
50	15	20	31	12	20	40	16	35
60	17	23	35	14	25	50	20	40
70	20	27	38	16	30	60	20	45
80	25	32	45	20	30	60	25	50
95	30	37	51	22	30	60	25	55
110	35	41	61	25	35	70	30	60
120	40	46	69	28	35	70	30	60
140	45	51	77	32	40	80	35	70
140	50	56	88	35	40	80	35	80
160	60	68	100	44	45	90	40	90
180	70	80	115	49	50	100	45	100
220	80	90	141	55	60	120	50	110

TYPE 40

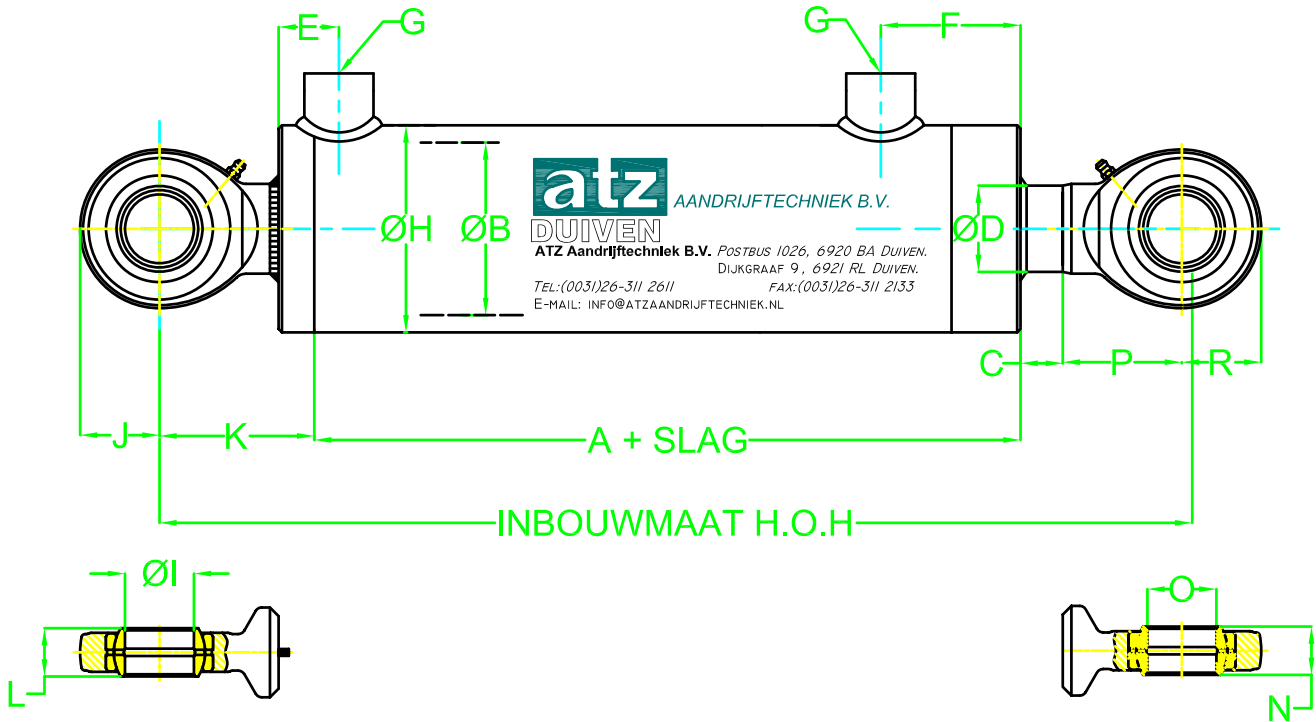

TYPE 40

BORING	STANG	A	B	C	D	E	F	G
25	15	94	25	16	15	15	48	1/4"
30	20	110	30	16	20	15	56	1/4"
40	25	117	40	16	25	20	56	1/4"
50	30	133	50	16	30	20	61	3/8"
60	35	141	60	16	35	20	65	3/8"
70	40	156	70	16	40	25	72	3/8"
80	45	174	80	21	45	25	83	1/2"
90	50	179	90	21	50	35	81	1/2"
100	50	179	100	21	50	35	81	1/2"
120	60	196	120	24	60	35	95	3/4"
120	70	196	120	24	70	35	95	3/4"
140	80	210	140	26	80	40	95	3/4"
160	90	232	160	33	90	50	100	3/4"
200	100	254	200	36	100	55	105	3/4"

H	I	J	K	L	N	O	P	R
35	10	15	24	9	9	10	24	15
40	12	17	27	10	10	12	27	17
50	15	20	31	12	12	15	31	20
60	17	23	35	14	14	17	35	23
70	20	27	38	16	16	20	38	27
80	25	32	45	20	20	25	45	32
95	30	37	51	22	22	30	51	37
110	35	41	61	25	25	35	61	41
120	40	46	69	28	28	40	69	46
140	45	51	77	32	32	45	77	51
140	50	56	88	35	35	50	88	56
160	60	68	100	44	44	60	100	68
180	70	80	115	49	49	70	115	80
220	80	90	141	55	55	80	141	90

TYPE 41

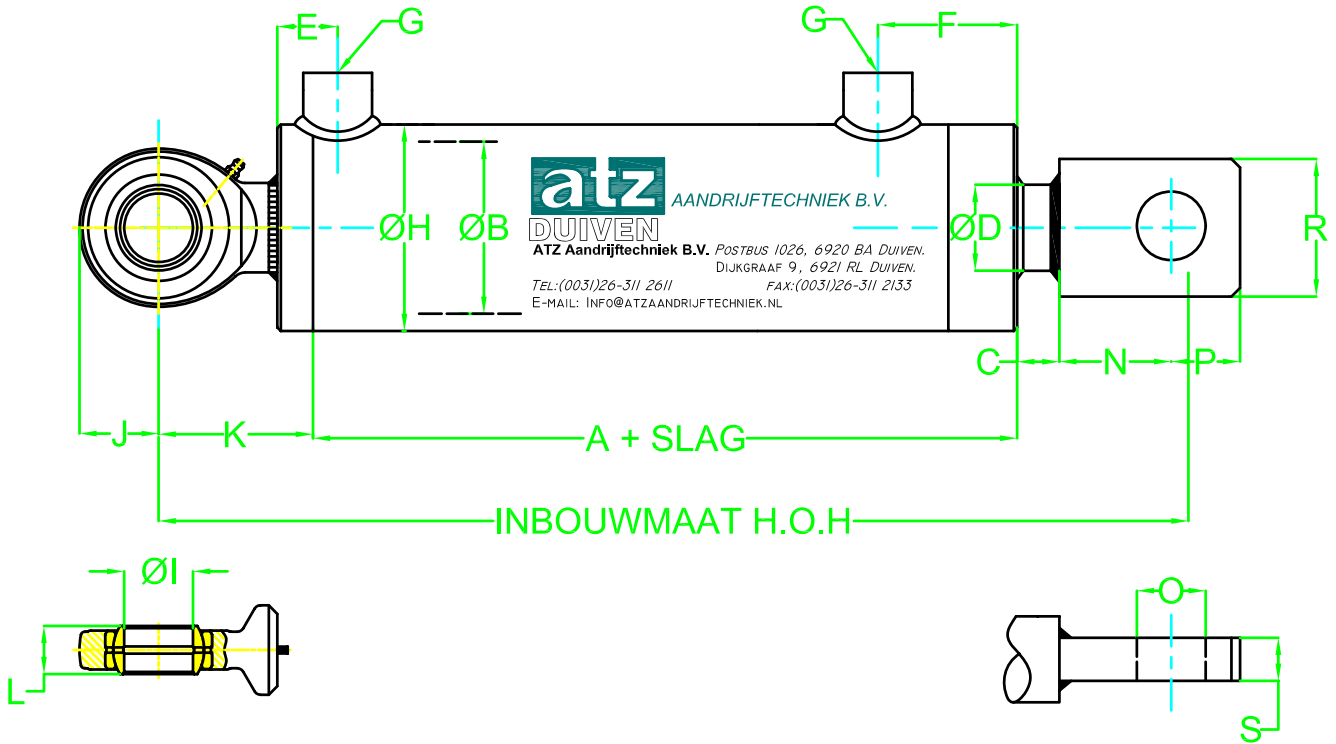

TYPE 41

BORINGSTANG	A	B	C	D	E	F	G	H
25	15	94	25	16	15	48	1/4"	35
30	20	110	30	16	20	56	1/4"	40
40	25	117	40	16	25	56	1/4"	50
50	30	133	50	16	30	61	3/8"	60
60	35	141	60	16	35	65	3/8"	70
70	40	156	70	16	40	72	3/8"	80
80	45	174	80	21	45	83	1/2"	95
90	50	179	90	21	50	81	1/2"	110
100	50	179	100	21	50	81	1/2"	120
120	60	196	120	24	60	95	3/4"	140
120	70	196	120	24	70	95	3/4"	140
140	80	210	140	26	80	95	3/4"	160
160	90	232	160	33	90	100	3/4"	180
200	100	254	200	36	100	105	3/4"	220

I	J	K	L	N	O	P	R	S
10	15	24	9	25	10	15	30	10
12	17	27	10	30	12	20	40	12
15	20	31	12	35	16	20	40	15
17	23	35	14	40	20	20	40	20
20	27	38	16	45	20	25	50	25
25	32	45	20	50	25	30	60	25
30	37	51	22	55	30	30	60	25
35	41	61	25	60	35	40	75	25
40	46	69	28	65	40	40	80	25
45	51	77	32	65	40	40	80	30
50	56	88	35	70	50	50	100	30
60	68	100	44	75	50	50	100	40
70	80	115	49	75	50	50	100	50
80	90	141	55	75	50	50	100	50

TYPE 42

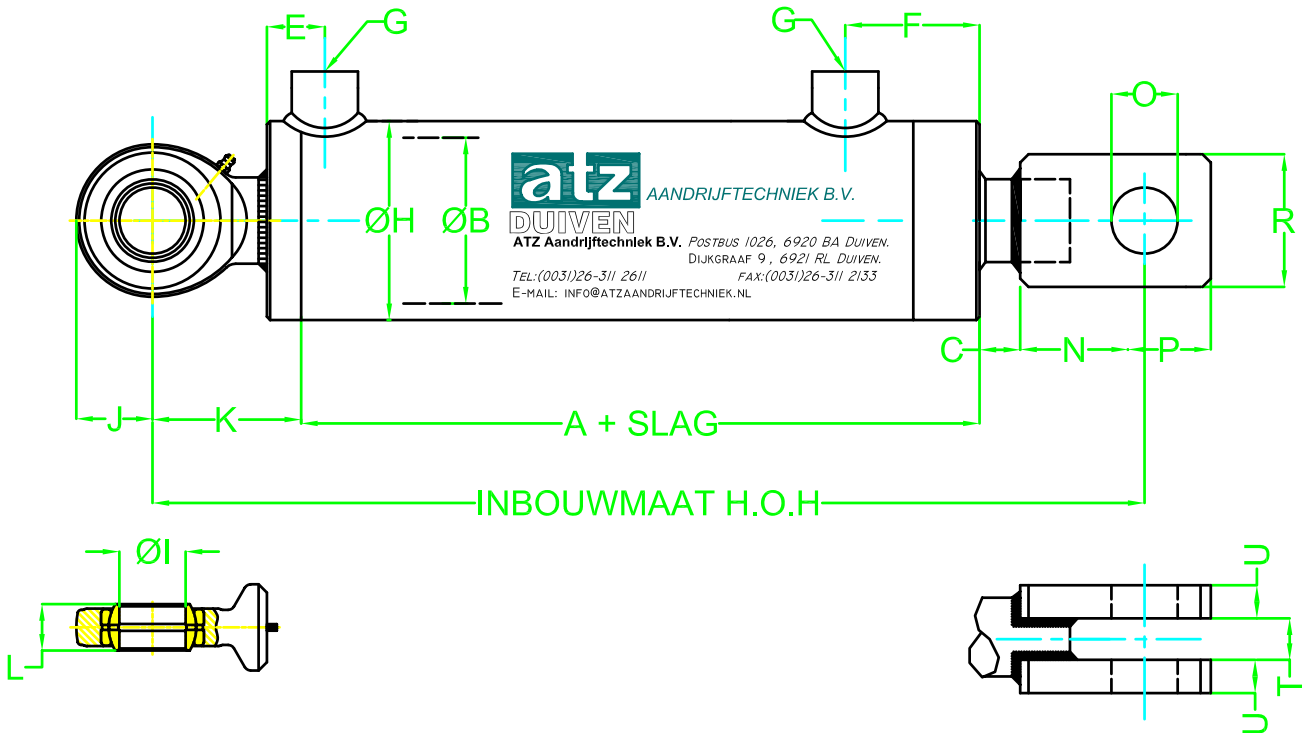

TYPE 42

BORINGSTANG	A	B	C	D	E	F	G	H	I	
25	15	94	25	10	15	15	48	1/4"	35	10
30	20	110	30	10	20	15	56	1/4"	40	12
40	25	117	40	10	25	20	56	1/4"	50	15
50	30	133	50	10	30	20	61	3/8"	60	17
60	35	141	60	13	35	20	65	3/8"	70	20
70	40	156	70	13	40	25	72	3/8"	80	25
80	45	174	80	13	45	25	83	1/2"	95	30
90	50	179	90	15	50	35	81	1/2"	110	35
100	50	179	100	15	50	35	81	1/2"	120	40
120	60	196	120	15	60	35	95	3/4"	140	45
120	70	196	120	18	70	35	95	3/4"	140	50
140	80	210	140	18	80	40	95	3/4"	160	60
160	90	232	160	20	90	50	100	3/4"	180	70
200	100	254	200	20	100	55	105	3/4"	220	80

J	K	L	N	O	P	R	S	T	U
15	24	9	40	10	15	30	15	10	8
17	27	10	45	12	20	40	15	12	8
20	31	12	50	16	20	40	20	15	10
23	35	14	55	20	20	40	20	20	12
27	38	16	60	20	25	50	25	20	12
32	45	20	65	25	30	60	25	20	15
37	51	22	70	30	30	60	25	25	15
41	61	25	75	35	40	75	25	25	15
46	69	28	85	40	40	80	30	25	20
51	77	32	95	40	40	80	35	30	20
56	88	35	100	50	50	100	35	30	20
68	100	44	110	50	50	100	40	40	25
80	115	49	125	50	50	100	50	50	30
90	141	55	125	50	50	100	50	50	30

TYPE 43

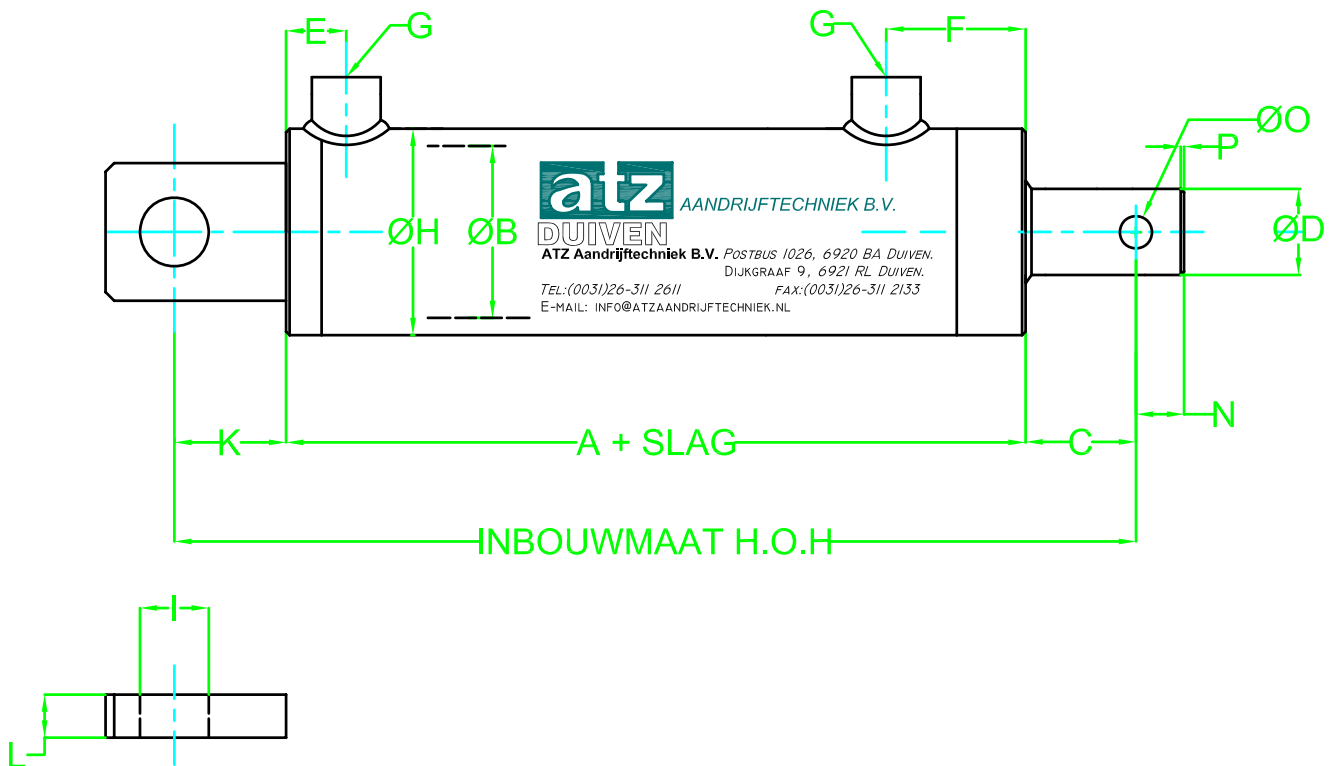

TYPE 43

BORING	STANG	A	B	C	D	E	F	G
25	15	94	25	11	15	15	48	1/4"
30	20	110	30	12	20	15	56	1/4"
40	25	117	40	12	25	20	56	1/4"
50	30	133	50	14	30	20	61	3/8"
60	35	141	60	15	35	20	65	3/8"
70	40	156	70	15	40	25	72	3/8"
80	45	174	80	20	45	25	83	1/2"
90	50	179	90	20	50	35	81	1/2"
100	50	179	100	20	50	35	81	1/2"
120	60	196	120	20	60	35	95	3/4"
120	70	196	120	22	70	35	95	3/4"
140	80	210	140	22	80	40	95	3/4"
160	90	232	160	22	90	50	100	3/4"
200	100	254	200	24	100	55	105	3/4"

H	I	J	K	L	M	N	O	P
35	10	15	25	10	30	10	8	1
40	12	20	30	12	40	15	10	1
50	16	20	35	15	40	20	12	1
60	20	20	40	20	40	20	15	1
70	20	25	45	25	50	22	16	2
80	25	30	50	25	60	25	20	2
95	30	30	55	30	60	27	25	2
110	35	40	60	25	75	30	25	2
120	40	40	65	25	80	30	25	2
140	40	40	65	30	80	35	30	3
140	50	50	70	30	100	37	30	3
160	50	50	75	40	100	40	35	3
180	50	50	75	50	100	45	40	3
220	50	50	75	50	100	50	50	3

TYPE 44

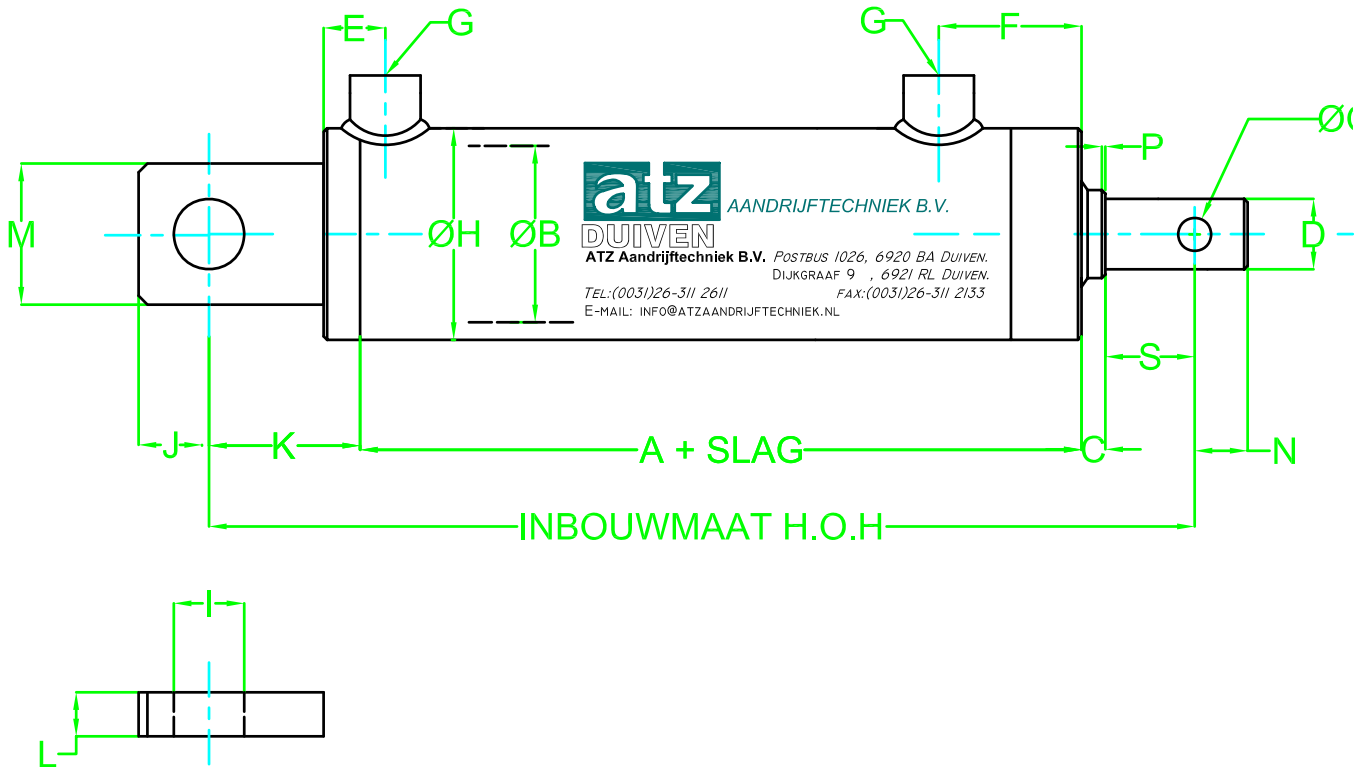

TYPE 44

BORING STANG	A	B	C	D	E	F	G	H	
25	15	94	25	6	15	15	48	1/4"	35
30	20	110	30	7	20	15	56	1/4"	40
40	25	117	40	8	25	20	56	1/4"	50
50	30	133	50	10	30	20	61	3/8"	60
60	35	141	60	10	35	20	65	3/8"	70
70	40	156	70	10	40	25	72	3/8"	80
80	45	174	80	12	45	25	83	1/2"	95
90	50	179	90	12	50	35	81	1/2"	110
100	50	179	100	12	50	35	81	1/2"	120
120	60	196	120	15	60	35	95	3/4"	140
120	70	196	120	15	70	35	95	3/4"	140
140	80	210	140	15	80	40	95	3/4"	160
160	90	232	160	15	90	50	100	3/4"	180
200	100	254	200	15	100	55	105	3/4"	220

I	J	K	L	M	N	O	P	R	S
10	15	25	10	30	10	7	1	12	14
12	20	30	12	40	12	9	1	15	18
16	20	35	15	40	15	12	1	20	22
20	20	40	20	40	15	15	2	25	22
20	25	45	25	50	18	16	2	30	24
25	30	50	25	60	20	20	2	35	25
30	30	55	30	60	25	20	2	40	25
35	40	60	25	75	25	25	3	45	28
40	40	65	25	80	25	25	3	45	28
40	40	65	30	80	30	30	4	50	30
50	50	70	30	100	30	30	4	60	30
50	50	75	40	100	35	30	4	70	35
50	50	75	50	100	40	35	4	80	40
50	50	75	50	100	45	40	4	90	45

TYPE 45

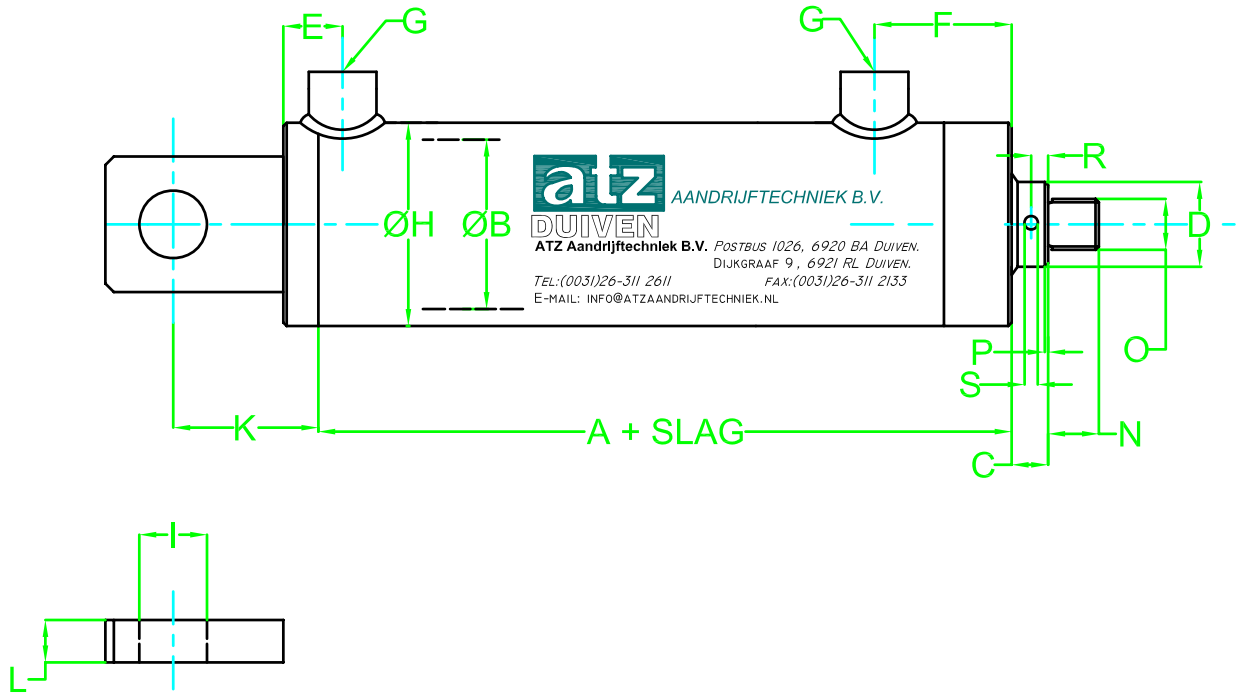

TYPE 45

BORINGSTANG	A	B	C	D	E	F	G	H	
25	15	94	25	11	15	15	48	1/4"	35
30	20	110	30	12	20	15	56	1/4"	40
40	25	117	40	12	25	20	56	1/4"	50
50	30	133	50	14	30	20	61	3/8"	60
60	35	133	60	15	35	20	65	3/8"	70
70	40	156	70	15	40	25	72	3/8"	80
80	45	174	80	20	45	25	83	1/2"	95
90	50	179	90	20	50	35	81	1/2"	110
100	50	179	100	20	50	35	81	1/2"	120
120	60	196	120	20	60	35	95	3/4"	140
120	70	196	120	22	70	35	95	3/4"	140
140	80	210	140	22	80	40	95	3/4"	160
160	90	232	160	22	90	50	100	3/4"	180
200	100	254	200	24	100	55	105	3/4"	220

I	J	K	L	M	N	O	P	R	S
10	15	25	10	30	14	14X1,5	1	5	4
12	20	30	12	40	15	16X1,5	1	6	5
16	20	35	15	40	18	16X1,5	1	6	5
20	20	40	20	40	18	18X1,5	2	7	6
20	25	45	25	50	25	20X1,5	2	7	6
25	30	50	25	60	25	22X1,5	2	7	6
30	30	55	30	60	30	27X2	3	10	8
35	40	60	25	75	30	27X2	3	10	8
40	40	65	25	80	30	30X2	3	10	8
40	40	65	30	80	50	33X2	3	10	8
50	50	70	30	100	50	33X2	4	12	10
50	50	75	40	100	50	40X2	4	12	10
50	50	75	50	100	60	50X2	4	12	10
50	50	75	50	100	60	64X2	4	12	10

TYPE 46

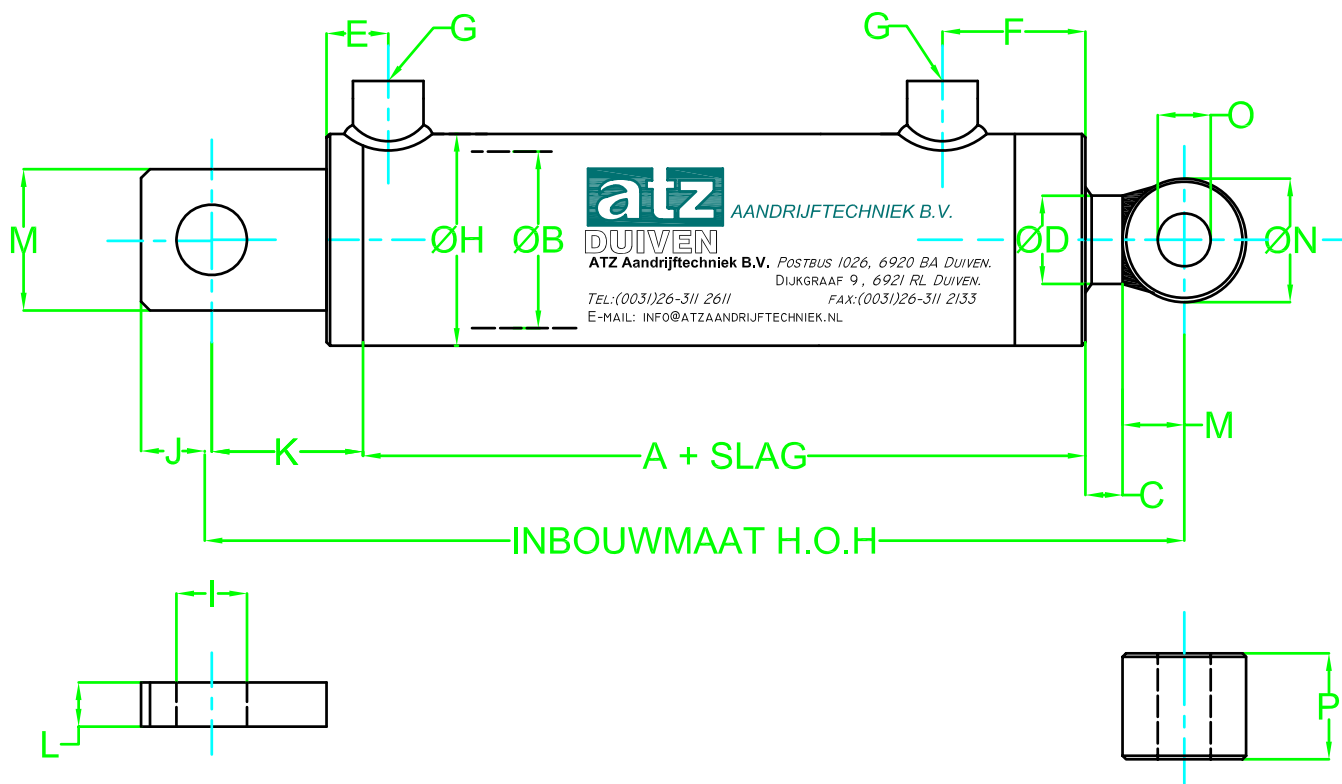

TYPE 46

BORING	STANG	A	B	C	D	E	F	G	H
25	15	94	25	16	15	15	48	1/4"	35
30	20	110	30	16	20	15	56	1/4"	40
40	25	117	40	16	25	20	56	1/4"	50
50	30	133	50	16	30	20	61	3/8"	60
60	35	141	60	16	35	20	65	3/8"	70
70	40	156	70	16	40	25	72	3/8"	80
80	45	174	80	21	45	25	83	1/2"	95
90	50	179	90	21	50	35	81	1/2"	110
100	50	179	100	21	50	35	81	1/2"	120
120	60	196	120	24	60	35	95	3/4"	140
120	70	196	120	24	70	35	95	3/4"	140
140	80	210	140	26	80	40	95	3/4"	160
160	90	232	160	33	90	50	100	3/4"	180
200	100	254	200	36	100	55	105	3/4"	220

I	J	K	L	M	N	O	P	R
10	15	25	10	30	15	10	25	30
12	20	30	12	40	20	12	30	40
16	20	35	15	40	20	16	35	40
20	20	40	20	40	25	20	40	50
20	25	45	25	50	30	20	45	60
25	30	50	25	60	30	25	50	60
30	30	55	30	60	30	25	55	60
35	40	60	25	75	35	30	60	70
40	40	65	25	80	35	30	60	70
40	40	65	30	80	40	35	70	80
50	50	70	30	100	40	35	80	80
50	50	75	40	100	45	40	90	90
50	50	75	50	100	50	45	100	100
50	50	75	50	100	60	50	110	120

TYPE 47

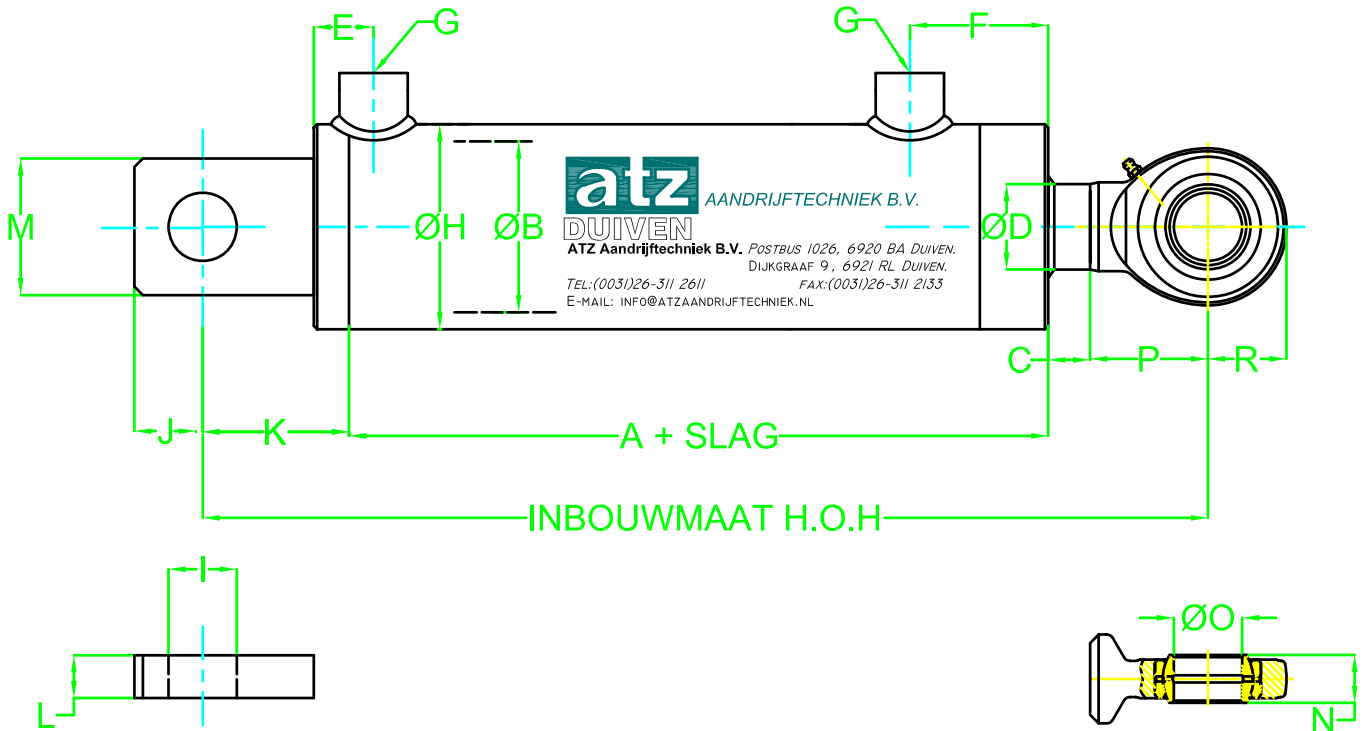

TYPE 47

BORING STANG	A	B	C	D	E	F	G	H	
25	15	94	25	16	15	15	48	1/4"	35
30	20	110	30	16	20	15	56	1/4"	40
40	25	117	40	16	25	20	56	1/4"	50
50	30	133	50	16	30	20	61	3/8"	60
60	35	141	60	16	35	20	65	3/8"	70
70	40	156	70	16	40	25	72	3/8"	80
80	45	174	80	21	45	25	83	1/2"	95
90	50	179	90	21	50	35	81	1/2"	110
100	50	179	100	21	50	35	81	1/2"	120
120	60	196	120	24	60	35	95	3/4"	140
120	70	196	120	24	70	35	95	3/4"	140
140	80	210	140	26	80	40	95	3/4"	160
160	90	232	160	33	90	50	100	3/4"	180
200	100	254	200	36	100	55	105	3/4"	220

I	J	K	L	M	N	O	P	R
10	15	25	10	30	9	10	24	15
12	20	30	12	40	10	12	27	17
16	20	35	15	40	12	15	31	20
20	20	40	20	40	14	17	35	23
20	25	45	25	50	16	20	38	27
25	30	50	25	60	20	25	45	32
30	30	55	30	60	22	30	51	37
35	40	60	25	75	25	35	61	41
40	40	65	25	80	28	40	69	46
40	40	65	30	80	32	45	77	51
50	50	70	30	100	35	50	88	56
50	50	75	40	100	44	60	100	68
50	50	75	50	100	49	70	115	80
50	50	75	50	100	55	80	141	90

TYPE 48

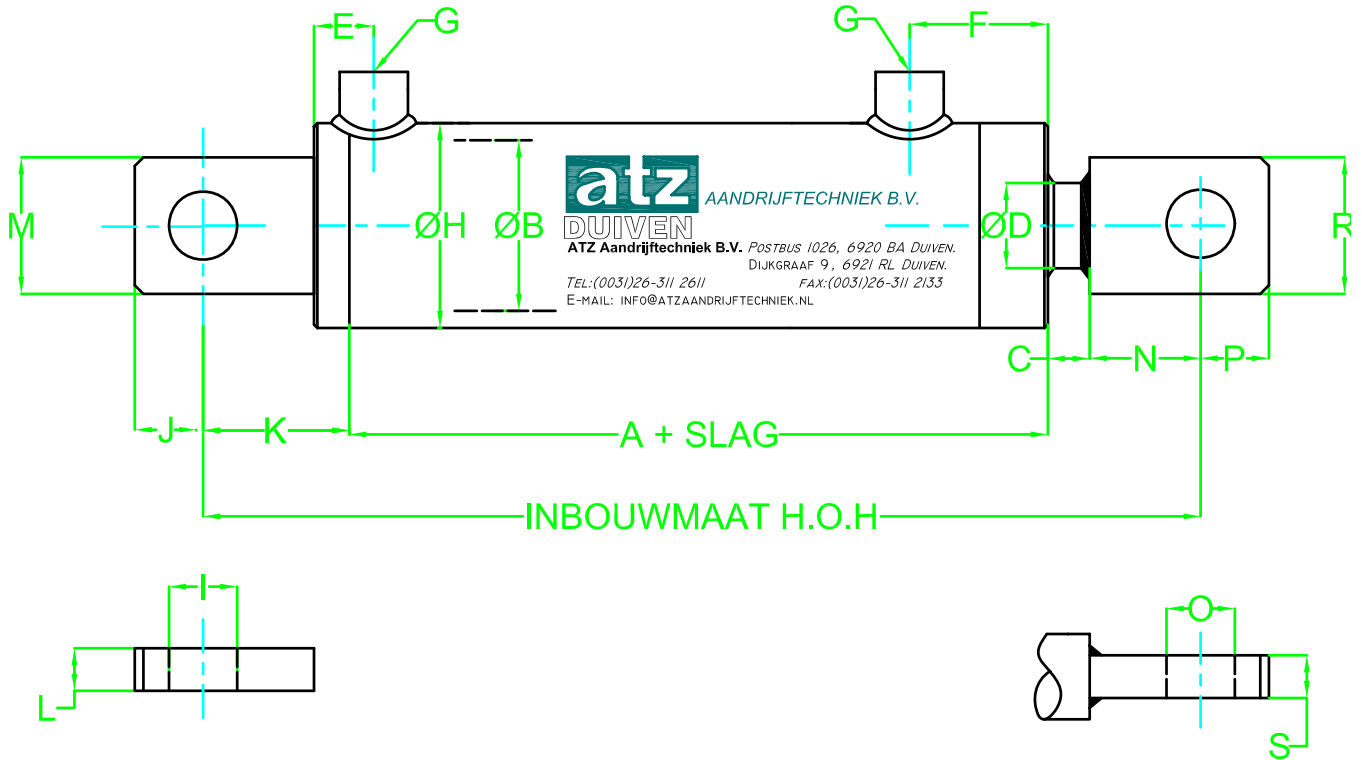

TYPE 48

BORING STANG	A	B	C	D	E	F	G	H	
25	15	94	25	16	15	15	48	1/4"	35
30	20	110	30	16	20	15	56	1/4"	40
40	25	117	40	16	25	20	56	1/4"	50
50	30	133	50	16	30	20	61	3/8"	60
60	35	141	60	16	35	20	65	3/8"	70
70	40	156	70	16	40	25	72	3/8"	80
80	45	174	80	21	45	25	83	1/2"	95
90	50	179	90	21	50	35	81	1/2"	110
100	50	179	100	21	50	35	81	1/2"	120
120	60	196	120	24	60	35	95	3/4"	140
120	70	196	120	24	70	35	95	3/4"	140
140	80	210	140	26	80	40	95	3/4"	160
160	90	232	160	33	90	50	100	3/4"	180
200	100	254	200	36	100	55	105	3/4"	220

I	J	K	L	M	N	O	P	R	S
10	15	25	10	30	25	10	15	30	10
12	20	30	12	40	30	12	20	40	12
16	20	35	15	40	35	16	20	40	15
20	20	40	20	40	40	20	20	40	20
20	25	45	25	50	45	20	25	50	25
25	30	50	25	60	50	25	30	60	25
30	30	55	30	60	55	30	30	60	30
35	40	60	25	75	60	35	40	75	25
40	40	65	25	80	65	40	40	80	25
40	40	65	30	80	65	40	40	80	30
50	50	70	30	100	70	50	50	100	30
50	50	75	40	100	75	50	50	100	40
50	50	75	50	100	75	50	50	100	50
50	50	75	50	100	75	50	50	100	50

TYPE 49

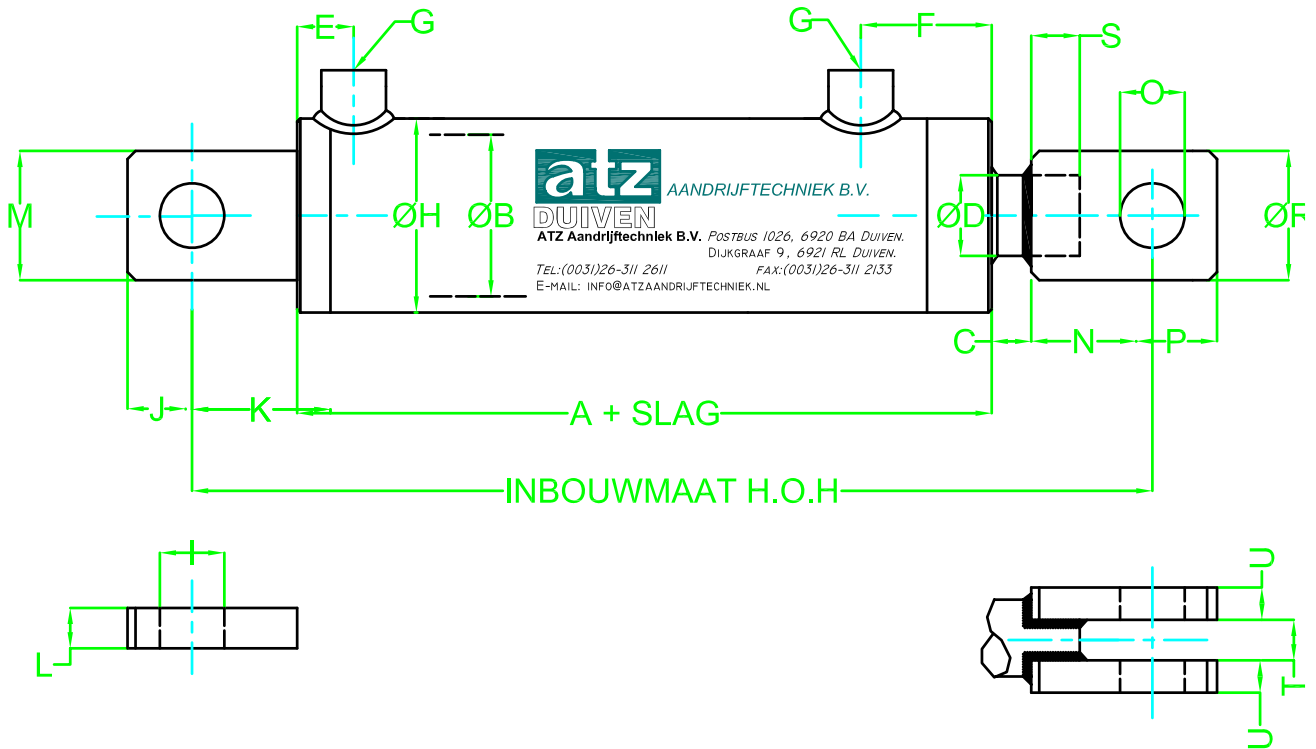

TYPE 49

BORINGSTANG	A	B	C	D	E	F	G	H	I	
25	15	94	25	10	15	15	48	1/4"	35	10
30	20	110	30	10	20	15	56	1/4"	40	12
40	25	117	40	10	25	20	56	1/4"	50	16
50	30	133	50	10	30	20	61	3/8"	60	20
60	35	141	60	13	35	20	65	3/8"	70	20
70	40	156	70	13	40	25	72	3/8"	80	25
80	45	174	80	13	45	25	83	1/2"	95	30
90	50	179	90	15	50	35	81	1/2"	110	35
100	50	179	100	15	50	35	81	1/2"	120	40
120	60	196	120	15	60	35	95	3/4"	140	40
120	70	196	120	18	70	35	95	3/4"	140	50
140	80	210	140	18	80	40	95	3/4"	160	50
160	90	232	160	20	90	50	100	3/4"	180	50
200	100	254	200	20	100	55	105	3/4"	220	50

J	K	L	M	N	O	P	R	S	T	U
15	25	10	30	40	10	15	30	15	10	8
20	30	12	40	45	12	20	40	15	12	8
20	35	15	40	50	16	20	40	20	15	10
20	40	20	40	55	20	20	40	20	20	12
25	45	25	50	60	20	25	50	25	20	12
30	50	25	60	65	25	30	60	25	20	15
30	55	30	60	70	30	30	60	25	25	15
40	60	25	75	75	35	40	75	25	25	15
40	65	25	80	85	40	40	80	30	25	20
40	65	30	80	95	40	40	80	35	30	20
50	70	30	100	100	50	50	100	35	30	20
50	75	40	100	110	50	50	100	40	40	25
50	75	50	100	125	50	50	100	50	50	30
50	75	50	100	125	50	50	100	50	50	30

TYPE 50

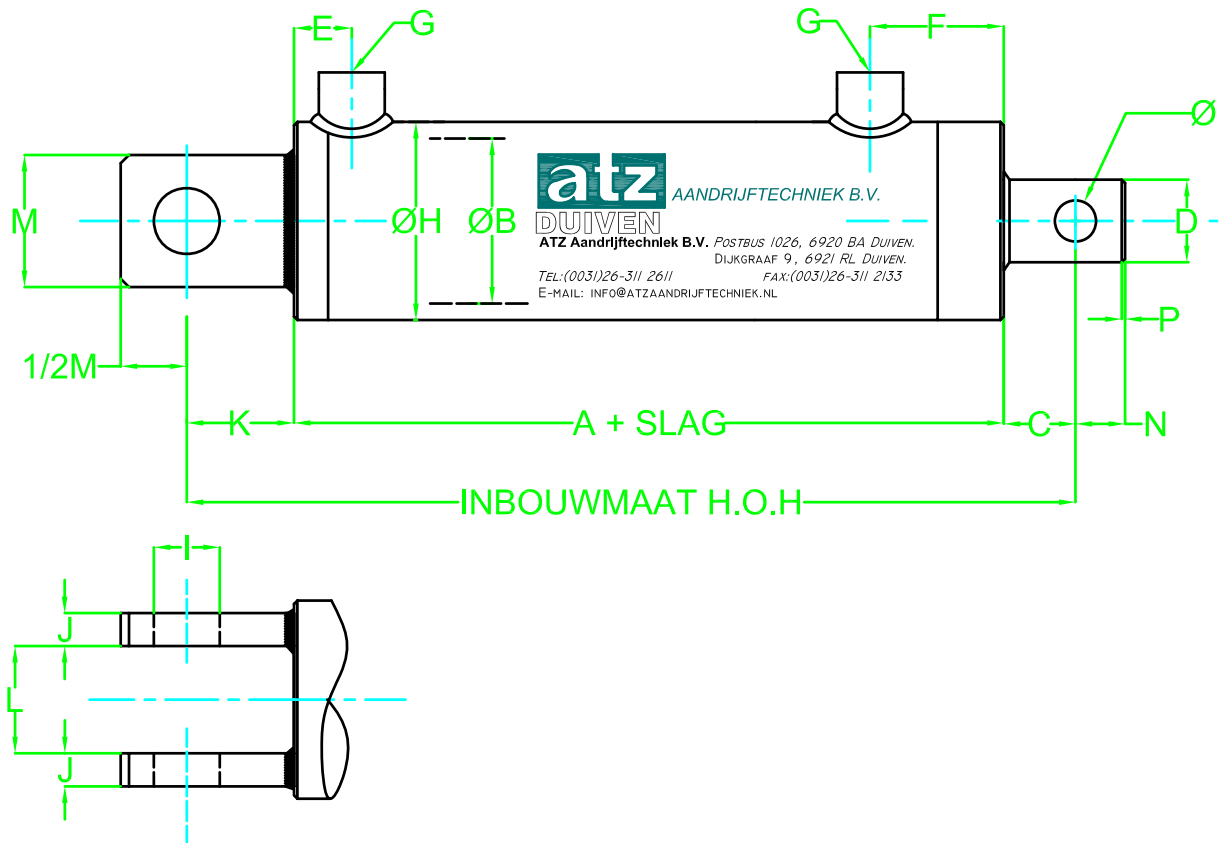

TYPE 50

BORING STANG	A	B	C	D	E	F	G	
25	15	94	25	20	15	15	48	1/4"
30	20	110	30	25	20	15	56	1/4"
40	25	117	40	30	25	20	56	1/4"
50	30	133	50	32	30	20	61	3/8"
60	35	141	60	34	35	20	65	3/8"
70	40	156	70	35	40	25	72	3/8"
80	45	174	80	37	45	25	83	1/2"
90	50	179	90	40	50	35	81	1/2"
100	50	179	100	40	50	35	81	1/2"
120	60	196	120	45	60	35	95	3/4"
120	70	196	120	45	70	35	95	3/4"
140	80	210	140	47	80	40	95	3/4"
160	90	232	160	50	90	50	100	3/4"
200	100	254	200	55	100	55	105	3/4"

H	I	J	K	L	M	N	O	P
35	10	8	25	10	30	10	8	1
40	12	8	30	12	40	15	10	1
50	16	10	35	15	40	20	12	1
60	20	12	40	20	40	20	15	1
70	20	12	45	20	50	22	16	2
80	25	15	50	20	60	25	20	2
95	30	15	55	25	60	27	25	2
110	35	15	60	25	75	30	25	2
120	40	20	65	25	80	30	25	2
140	40	20	65	30	80	35	30	3
140	50	20	70	30	100	37	30	3
160	50	25	75	40	100	40	35	3
180	50	30	75	50	100	45	40	3
220	50	30	75	50	100	50	50	3

TYPE 51

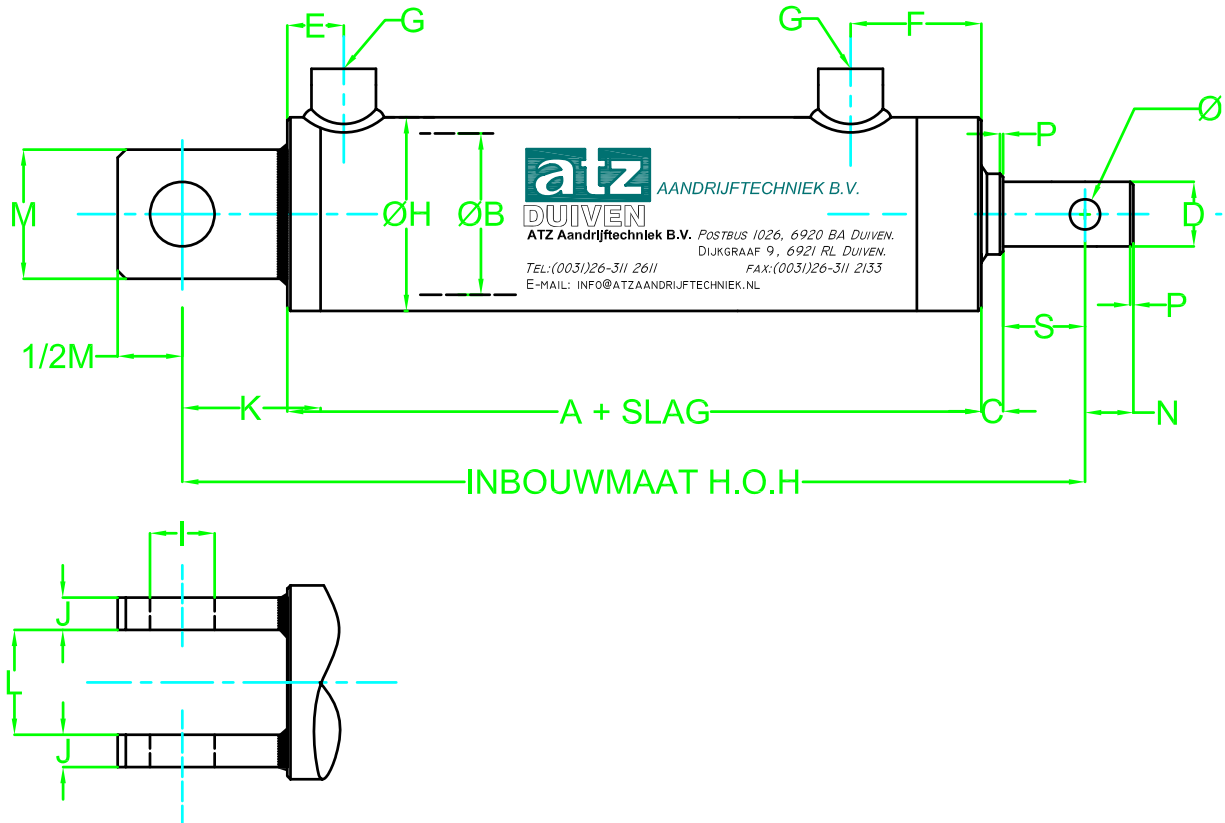

TYPE 51

BORING STANG	A	B	C	D	E	F	G	H	
25	15	94	25	6	15	15	48	1/4"	35
30	20	110	30	7	20	15	56	1/4"	40
40	25	117	40	8	25	20	56	1/4"	50
50	30	133	50	10	30	20	61	3/8"	60
60	35	141	60	10	35	20	65	3/8"	70
70	40	156	70	10	40	25	72	3/8"	80
80	45	174	80	12	45	25	83	1/2"	95
90	50	179	90	12	50	35	81	1/2"	110
100	50	179	100	12	50	35	81	1/2"	120
120	60	196	120	15	60	35	95	3/4"	140
120	70	196	120	15	70	35	95	3/4"	140
140	80	210	140	15	80	40	95	3/4"	160
160	90	232	160	15	90	50	100	3/4"	180
200	100	254	200	15	100	55	105	3/4"	220

I	J	K	L	M	N	O	P	R	S
10	8	25	10	30	10	7	1	12	14
12	8	30	12	40	12	9	1	15	18
16	10	35	15	40	15	12	1	20	22
20	12	40	20	40	15	15	2	25	22
20	12	45	20	50	18	16	2	30	24
25	15	50	20	60	20	20	2	35	25
30	15	55	25	60	25	20	2	40	25
35	15	60	25	75	25	25	3	45	28
40	20	65	25	80	25	25	3	45	28
40	20	65	30	80	30	30	4	50	30
50	20	70	30	100	30	30	4	60	30
50	25	75	40	100	35	30	4	70	35
50	30	75	50	100	40	35	4	80	40
50	30	75	50	100	45	40	4	90	45

TYPE 52

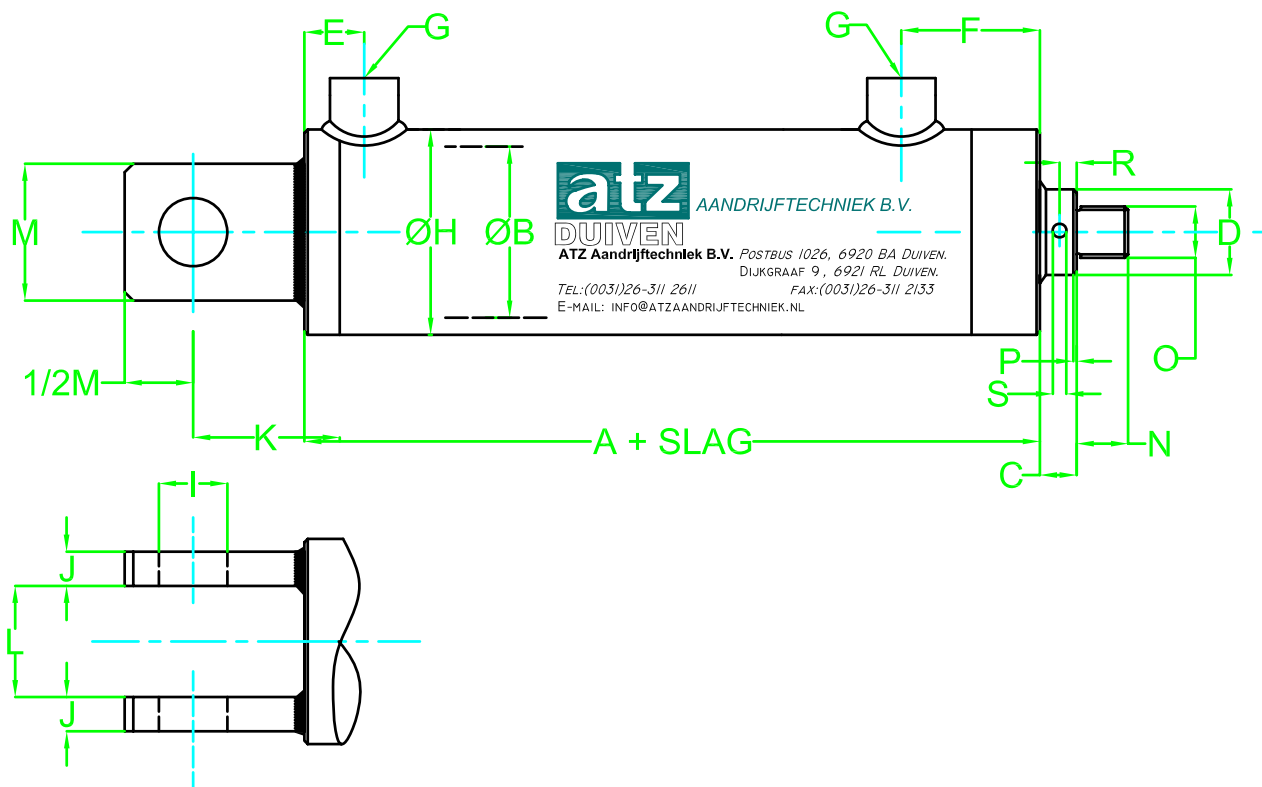

TYPE 52

BORING STANG	A	B	C	D	E	F	G	H	
25	15	94	25	11	15	15	48	1/4"	35
30	20	110	30	12	20	15	56	1/4"	40
40	25	117	40	12	25	20	56	1/4"	50
50	30	133	50	14	30	20	61	3/8"	60
60	35	141	60	15	35	20	65	3/8"	70
70	40	156	70	15	40	25	72	3/8"	80
80	45	174	80	20	45	25	83	1/2"	95
90	50	179	90	20	50	35	81	1/2"	110
100	50	179	100	20	50	35	81	1/2"	120
120	60	196	120	20	60	35	95	3/4"	140
120	70	196	120	22	70	35	95	3/4"	140
140	80	210	140	22	80	40	95	3/4"	160
160	90	232	160	22	90	50	100	3/4"	180
200	100	254	200	24	100	55	105	3/4"	220

I	J	K	L	M	N	O	P	R	S
10	8	25	10	30	14	14X1,5	1	5	4
12	8	30	12	40	15	16X1,5	1	6	5
16	10	35	15	40	18	16X1,5	1	6	5
20	12	40	20	40	18	18X1,5	2	7	6
20	12	45	20	50	25	20X1,5	2	7	6
25	15	50	20	60	25	22X1,5	2	7	6
30	15	55	25	60	30	27X2	3	10	8
35	15	60	25	75	30	27X2	3	10	8
40	20	65	25	80	30	30X2	3	10	8
40	20	65	30	80	50	33X2	3	10	8
50	20	70	30	100	50	33X2	4	12	10
50	25	75	40	100	50	40X2	4	12	10
50	30	75	50	100	60	50X2	4	12	10
50	30	75	50	100	60	64X3	4	12	10

TYPE 53

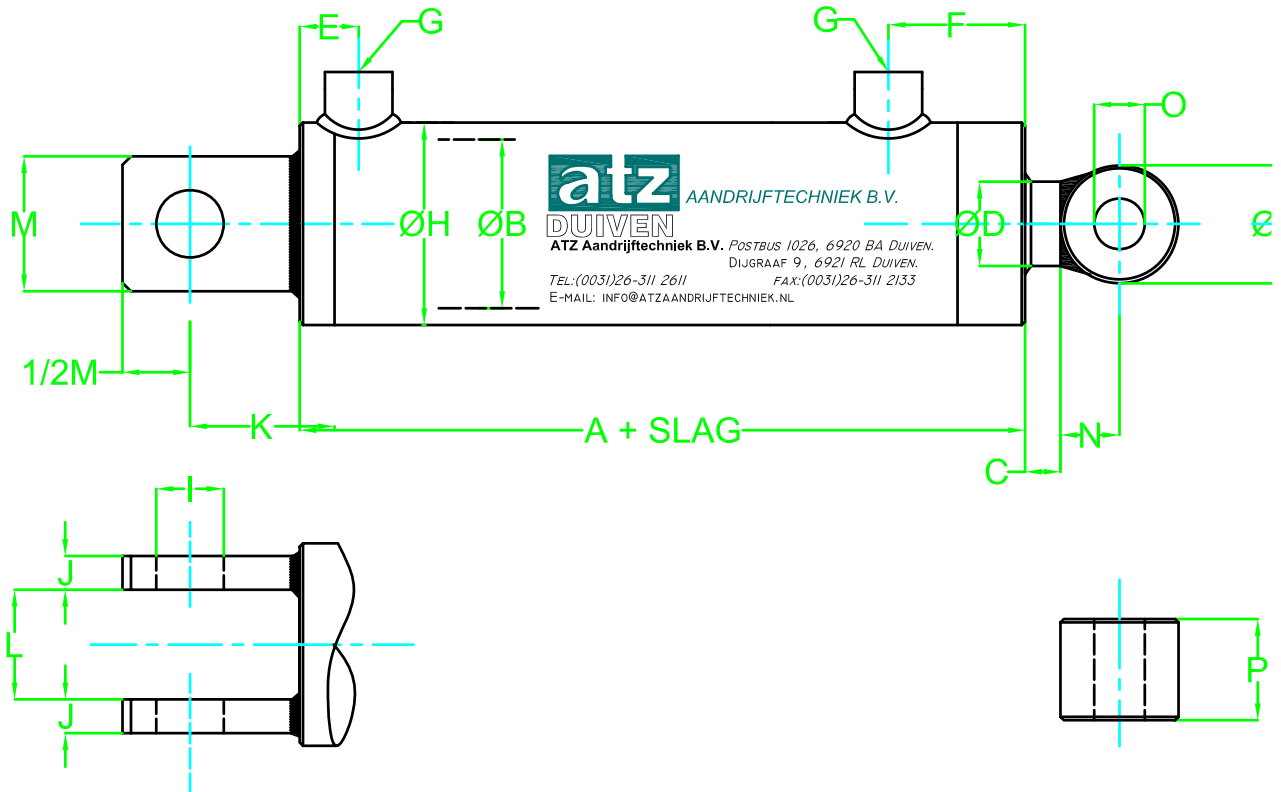

TYPE 53

BORING STANG	A	B	C	D	E	F	G	H	
25	15	94	25	16	15	15	48	1/4"	35
30	20	110	30	16	20	15	56	1/4"	40
40	25	117	40	16	25	20	56	1/4"	50
50	30	133	50	16	30	20	61	3/8"	60
60	35	141	60	16	35	20	65	3/8"	70
70	40	156	70	16	40	25	72	3/8"	80
80	45	174	80	21	45	25	83	1/2"	95
90	50	179	90	21	50	35	81	1/2"	110
100	50	179	100	21	50	35	81	1/2"	120
120	60	196	120	24	60	35	95	3/4"	140
120	70	196	120	24	70	35	95	3/4"	140
140	80	210	140	26	80	40	95	3/4"	160
160	90	232	160	33	90	50	100	3/4"	180
200	100	254	200	36	100	55	105	3/4"	220

I	J	K	L	M	N	O	P	R
10	8	25	10	30	15	10	25	30
12	8	30	12	40	20	12	30	40
16	10	35	15	40	20	16	35	40
20	12	40	20	40	25	20	40	50
20	12	45	20	50	30	20	45	60
25	15	50	20	60	30	25	50	60
30	15	55	25	60	30	25	55	60
35	15	60	25	75	35	30	60	70
41	20	65	25	80	35	30	60	70
40	20	65	30	80	40	35	70	80
50	20	70	30	100	40	35	80	80
50	25	75	40	100	45	40	90	90
50	30	75	50	100	50	45	100	100
50	30	75	50	100	60	50	110	120

TYPE 54

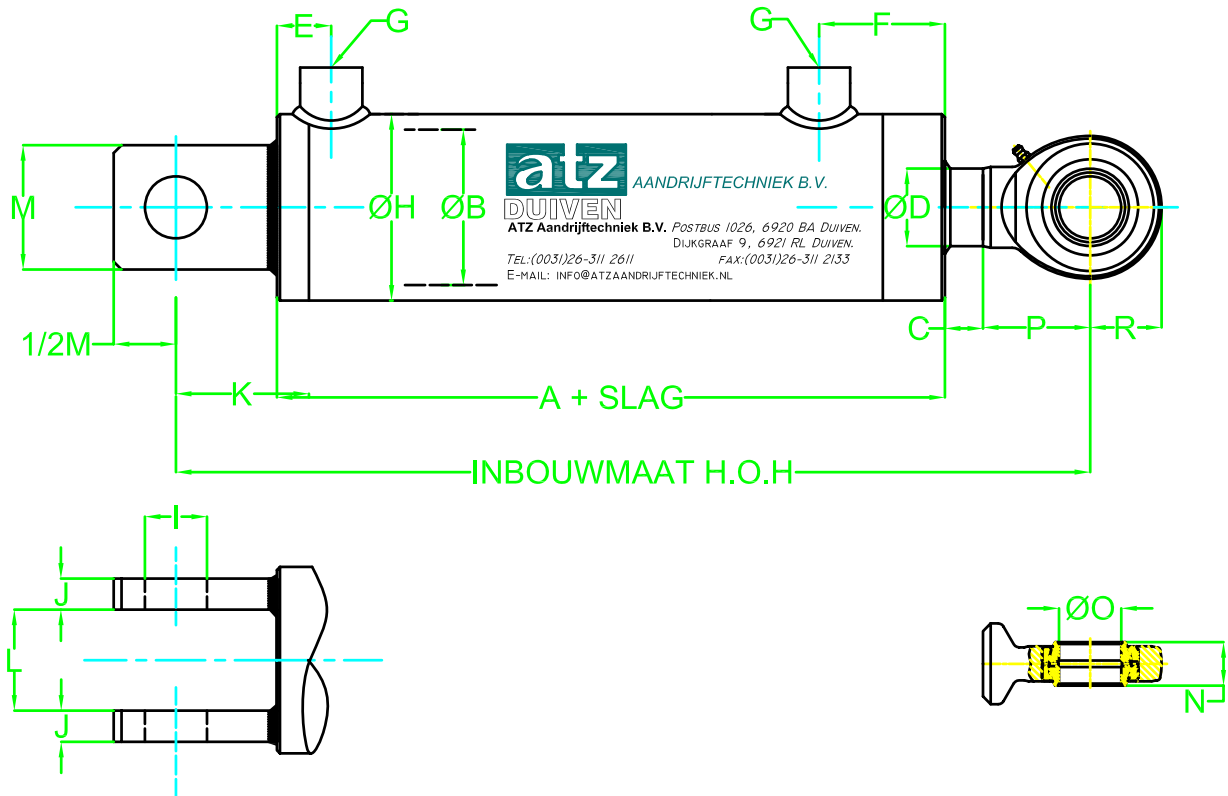

TYPE 54

BORING STANG	A	B	C	D	E	F	G	H	
25	15	94	25	16	15	15	48	1/4"	35
30	20	110	30	16	20	15	56	1/4"	40
40	25	117	40	16	25	20	56	1/4"	50
50	30	133	50	16	30	20	61	3/8"	60
60	35	141	60	16	35	20	65	3/8"	70
70	40	156	70	16	40	25	72	3/8"	80
80	45	174	80	21	45	25	83	1/2"	95
90	50	179	90	21	50	35	81	1/2"	110
100	50	179	100	21	50	35	81	1/2"	120
120	60	196	120	24	60	35	95	3/4"	140
120	70	196	120	24	70	35	95	3/4"	140
140	80	210	140	26	80	40	95	3/4"	160
160	90	232	160	33	90	50	100	3/4"	180
200	100	254	200	36	100	55	105	3/4"	220

I	J	K	L	M	N	O	P	R
10	8	25	10	30	9	10	24	15
12	8	30	12	40	10	12	27	17
16	10	35	15	40	12	15	31	20
20	12	40	20	40	14	17	35	23
20	12	45	20	50	16	20	38	27
25	15	50	20	60	20	25	45	32
30	15	55	25	60	22	30	51	37
35	15	60	25	75	25	35	61	41
40	20	65	25	80	28	40	69	46
40	20	65	30	80	32	45	77	51
50	20	70	30	100	35	50	88	56
50	25	75	40	100	44	60	100	68
50	30	75	50	100	49	70	115	80
50	30	75	50	100	55	80	141	90

TYPE 55

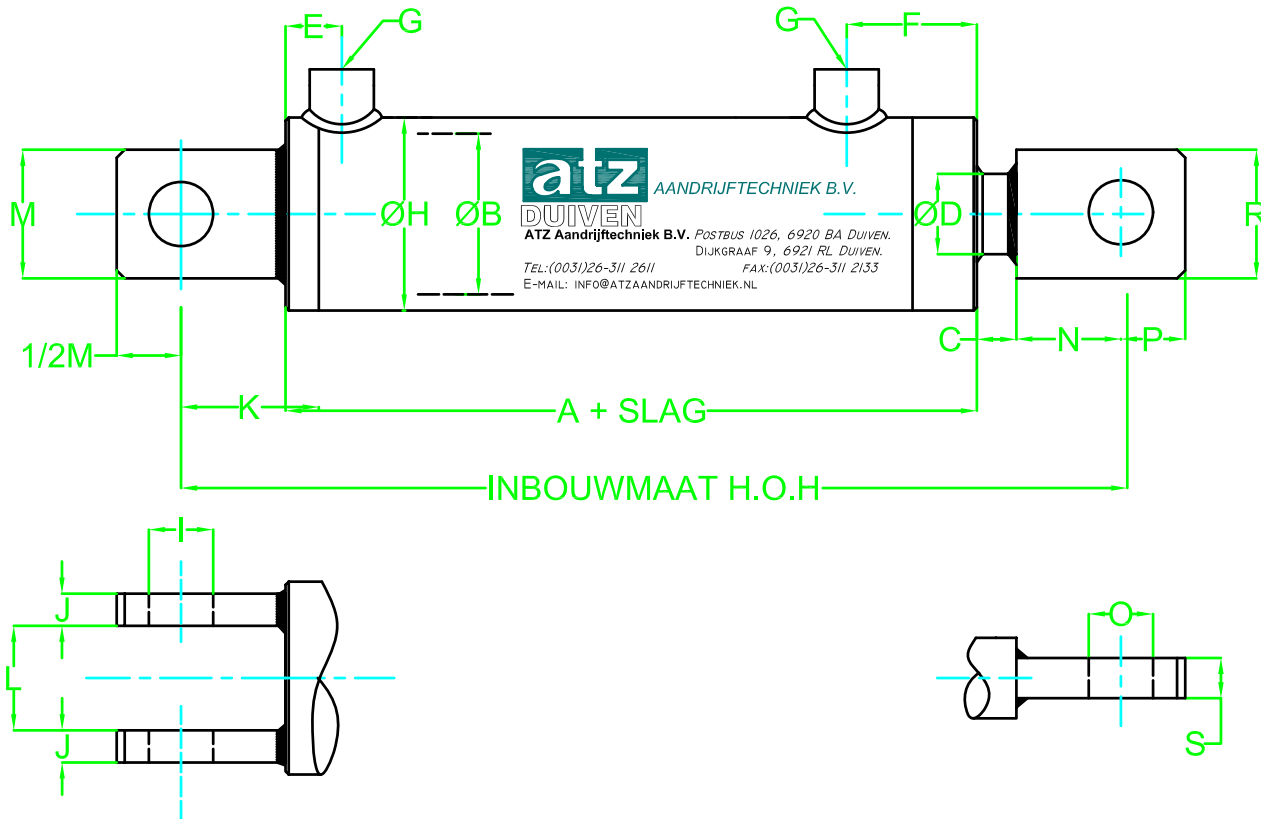

TYPE 55

BORING STANG	A	B	C	D	E	F	G	H	
25	15	94	25	16	15	15	48	1/4"	35
30	20	110	30	16	20	15	56	1/4"	40
40	25	117	40	16	25	20	56	1/4"	50
50	30	133	50	16	30	20	61	3/8"	60
60	35	141	60	16	35	20	65	3/8"	70
70	40	156	70	16	40	25	72	3/8"	80
80	45	174	80	21	45	25	83	1/2"	95
90	50	179	90	21	50	35	81	1/2"	110
100	50	179	100	21	50	35	81	1/2"	120
120	60	196	120	24	60	35	95	3/4"	140
120	70	196	120	24	70	35	95	3/4"	140
140	80	210	140	26	80	40	95	3/4"	160
160	90	232	160	33	90	50	100	3/4"	180
200	100	254	200	36	100	55	105	3/4"	220

I	J	K	L	M	N	O	P	R	S
10	8	25	10	30	25	10	15	30	10
12	8	30	12	40	30	12	20	40	12
16	10	35	15	40	35	16	20	40	15
20	12	40	20	40	40	20	20	40	20
20	12	45	20	50	45	20	25	50	25
25	15	50	20	60	50	25	30	60	25
30	15	55	25	60	55	30	30	60	30
35	15	60	25	75	60	35	40	75	25
40	20	65	25	80	65	40	40	80	25
40	20	65	30	80	65	40	40	80	30
50	20	70	30	100	70	50	50	100	30
50	25	75	40	100	75	50	50	100	40
50	30	75	50	100	75	50	50	100	50
50	30	75	50	100	75	50	50	100	50

TYPE 56

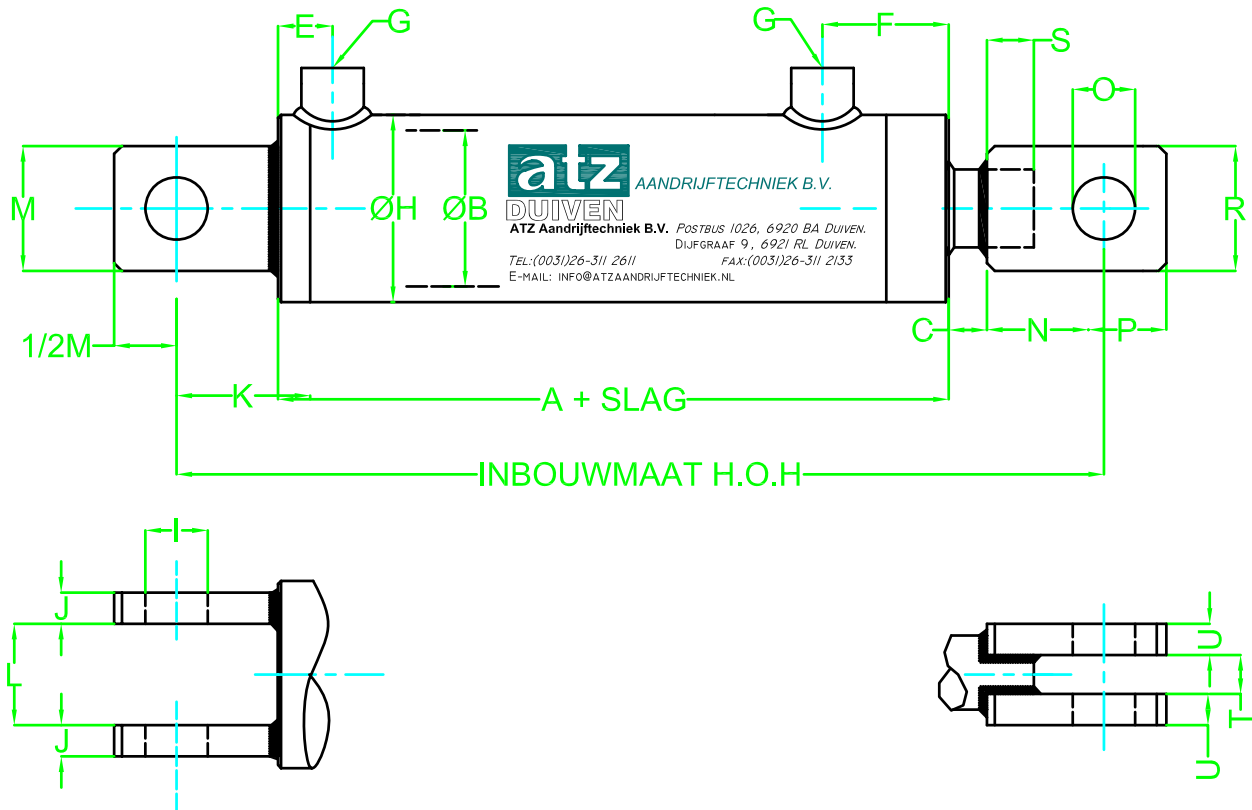

TYPE 56

BORINGSTANG	A	B	C	D	E	F	G	H	I	
25	15	94	25	10	15	15	48	1/4"	35	10
30	20	110	30	10	20	15	56	1/4"	40	12
40	25	117	40	10	25	20	56	1/4"	50	16
50	30	133	50	10	30	20	61	3/8"	60	20
60	35	141	60	13	35	20	65	3/8"	70	20
70	40	156	70	13	40	25	72	3/8"	80	25
80	45	174	80	13	45	25	83	1/2"	95	30
90	50	179	90	15	50	35	81	1/2"	110	35
100	50	179	100	15	50	35	81	1/2"	120	40
120	60	196	120	15	60	35	95	3/4"	140	40
120	70	196	120	18	70	35	95	3/4"	140	50
140	80	210	140	18	80	40	95	3/4"	160	50
160	90	232	160	20	90	50	100	3/4"	180	50
200	100	254	200	20	100	55	105	3/4"	220	50

J	K	L	M	N	O	P	R	S	T	U
8	25	10	30	40	10	15	30	15	10	8
8	30	12	40	45	12	20	40	15	12	8
10	35	15	40	50	16	20	40	20	15	10
12	40	20	40	55	20	20	40	20	20	12
12	45	20	50	60	20	25	50	25	20	12
15	50	20	60	65	25	30	60	25	20	15
15	55	25	60	70	30	30	60	25	25	15
15	60	25	75	75	35	40	75	25	25	15
20	65	25	80	85	40	40	80	30	25	20
20	65	30	80	95	40	40	80	35	30	20
20	70	30	100	100	50	50	100	35	30	20
25	75	40	100	110	50	50	100	40	40	25
30	75	50	100	125	50	50	100	50	50	30
30	75	50	100	125	50	50	100	50	50	30